

# Operating Instructions

Convertible Camera

AW-E750

AW-E655

AW-E650

AW-E350

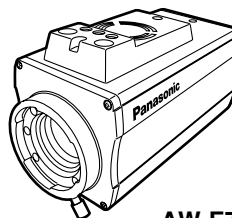

AW-E750

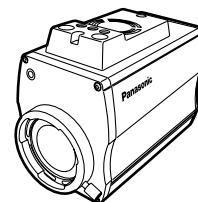

AW-E655

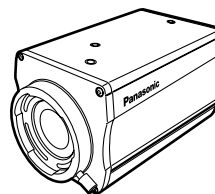

AW-E650

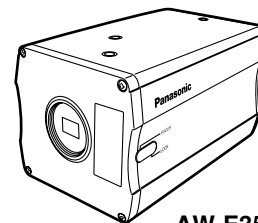

AW-E350

## Panasonic®

Before attempting to connect, operate or adjust this product,  
please read these instructions completely.



**CAUTION**  
**RISK OF ELECTRIC SHOCK**  
**DO NOT OPEN**



CAUTION: TO REDUCE THE RISK OF ELECTRIC SHOCK,  
 DO NOT REMOVE COVER (OR BACK).  
 NO USER SERVICEABLE PARTS INSIDE.  
 REFER TO SERVICING TO QUALIFIED SERVICE PERSONNEL.



The lightning flash with arrowhead symbol, within an equilateral triangle, is intended to alert the user to the presence of uninsulated “dangerous voltage” within the product’s enclosure that may be of sufficient magnitude to constitute a risk of electric shock to persons.



The exclamation point within an equilateral triangle is intended to alert the user to the presence of important operating and maintenance (service) instructions in the literature accompanying the appliance.

## **WARNING:**

**TO REDUCE THE RISK OF FIRE OR SHOCK HAZARD, DO NOT EXPOSE THIS EQUIPMENT TO RAIN OR MOISTURE.**

## **CAUTION:**

**TO REDUCE THE RISK OF FIRE OR SHOCK HAZARD AND ANNOYING INTERFERENCE, USE THE RECOMMENDED ACCESSORIES ONLY.**

### **FCC Note:**

This device complies with Part 15 of the FCC Rules. To assure continued compliance follow the attached installation instructions and do not make any unauthorized modifications.

This equipment has been tested and found to comply with the limits for a class A digital device, pursuant to Part 15 of the FCC Rules. These limits are designed to provide reasonable protection against harmful interference when the equipment is operated in a commercial environment. This equipment generates, uses, and can radiate radio frequency energy and, if not installed and used in accordance with the instruction manual, may cause harmful interference to radio communications. Operation of this equipment in a residential area is likely to cause harmful interference in which case the user will be required to correct the interference at his own expense.

For CANADA

This Class A digital apparatus complies with Canadian ICES-003.

Cet appareil numérique de la class A est conforme à la norme NMB-003 du Canada.

The serial number of this product may be found on the bottom of the unit.

# CONTENTS

- PREFACE ..... 4
- FEATURES ..... 5
- SPECIAL NOTES ON OPERATION ..... 6
- PRECAUTIONS ..... 7
- MAJOR OPERATING CONTROLS AND THEIR FUNCTIONS ..... 9
- MOUNTING ..... 13
- FLANGE BACK ADJUSTMENT (FOR ZOOM LENS) ..... 15
- IRIS GAIN CONTROL IN A LENS ..... 17
- CONNECTIONS ..... 18
- ADJUSTMENT ..... 23
- USE MODE SETTING ..... 29
- MENU ITEM SETTING ..... 31
- SETTING AND CHANGING THE OPTIONAL CARDS ..... 54
- SETTING TO INITIAL SET ..... 56
- APPEARANCE ..... 60
- SPECIFICATIONS ..... 64
- STANDARD ACCESSORIES ..... 68

# PREFACE

- The Panasonic AW-E750, AW-E655, AW-E650 and AW-E350 are digital signal processing color video cameras that incorporate three CCDs;

2/3" 3CCD (AW-E750)

1/2" 3CCD (AW-E655, AW-E650)

1/3" 3CCD (AW-E350)

A digital video signal processing system is packed in a compact, lightweight body while assuring high picture quality, high reliability and high performance.

- System setup and adjustments can be easily performed by following the setup menu.
- Connection to peripheral devices, such as a RCU, a RCB and a lens and the camera pan/tilt unit enables a wide variation of system configurations.
- Option cards may also be installed.

\* The following cards are not available for AW-E750, AW-E655, AW-E650, AW-E350;

- AW-PB301 Component Studio Card
- AW-PB302 RGB Card: The camera unit contains this function.
- AW-PB303 High-sensitivity Card: The camera unit contains this function.
- AW-PB304 SDI Card: Use AW-PB504.
- AW-PB306 Studio SDI Card: Use AW-PB506.
- AW-PB307 SVGA card
- AW-PB309 WEB card
- AW-PB310 IEEE 1394 Card

# FEATURES

1. Digital video signal processing for high quality, high reliability, high performance, lightweight and compact size.
2. Resolution: 850 lines (HIGH BAND DTL: ON)  
S/N ratio:  
67dB (DNR ON) (AW-E750, AW-E655, AW-E650)  
66dB (DNR ON) (AW-E350)
3. Minimum illumination:  
0.00005 lx (AW-E750, AW-E655, AW-E650)  
0.00015 lx (AW-E350)
4. The built-in CCD storage function and digital gain up function provide an even higher degree of high sensitivity.
5. RGB, Y/Pr/Pb and Y/C signal output circuits provided.
6. Motorized filters containing IR through and ND filters (1/16, 1/64) incorporated (model AW-E655 only).
7. Built-in automatic controls, including ATW, ELC, and AGC.
8. CCD readout is switchable between field and frame modes. Vertical resolution can be stepped up in frame mode and it is effective for shooting still objects.
9. The built-in synchronized scanning system reduces noise in computer graphics.
10. Various correction circuits permit video reproduction with high fidelity.
11. Chroma detail correction enables clear shots of dark color objects.
12. A dark detail circuit provides natural edge correction to any object in a dark scene.
13. A digital color matrix enables high fidelity color images.
14. The 12-axis digital color matrix enables users' to create images of their choice.
15. Four use modes for each of your specific applications can be selected.
16. SMPTE color bar is indicated on the monitor screen.
17. Remote control with a RCU, RCB or a Hybrid control panel.

## SPECIAL NOTES ON OPERATION

- Turn power off before connecting or disconnecting cables.
- Connection or disconnection of any studio cable, RCB cable or other cable to any unit of equipment must be performed while power is off.
- While the camera is in automatic mode; Shooting of bright objects in ELC operation mode may result in a smeared picture unique to the CCD. The ATW function under fluorescent illumination can adversely change the white balance.
- There is a cooling fan inside.  
Do not cover the port or otherwise block ventilation during operation. Internal heat buildup can cause a fire.  
It is an expendable part, and must be replaced about every 30 000 hours. (Whenever fan replacement is necessary, be sure to ask the store where you purchased the set.) (AW-E750, AW-E655)

# PRECAUTIONS

## DON'TS

- Do not attempt to disassemble the camera, Remote Control Unit (RCU) or other units. In order to prevent electric shock, do not remove screws or covers. There are no user-serviceable parts inside.
- Do not abuse the camera. Avoid striking, shaking, etc. The camera contains sensitive components which could be damaged by improper handling or storage.
- Do not let the lens remain uncapped when the camera is not in use. If the lens is not installed, do not leave the lens mount hole uncovered.
- Do not touch the surface of the lens or prism.
- Do not use strong or abrasive detergents when cleaning the camera body.
- Do not aim the camera toward the sun, no matter whether it is turned on or not.
- Do not expose the camera or Remote Control Unit (RCU) to rain or moisture, and do not try to operate the equipment in wet conditions. Do not operate the camera or RCU if it becomes wet.
- Do not operate the camera or Remote Control Unit (RCU) outdoors during a lightning storm.
- Do not use the camera in an extreme environment where high temperatures or high humidity exist.
- Do not leave the camera and Remote Control Unit (RCU) turned on when not in use. Do not unnecessarily turn the camera power on and off repeatedly. Do not block the ventilation slots.
- Do not cover the port otherwise block ventilation during operation. Internal heat buildup can cause a fire.

## DOS

- Refer any servicing to qualified service personnel.
- Handle the camera with care.
- Protect the precision made lens by placing the lens cap over when the camera is not in use. If the lens is not installed, protect the surface of the prism by placing the body cap into the lens mount hole.
- Use a mild blower or lens cleaning tissue designed for coated lenses, to clean the surface of the lens or prism in the event that it should become dirty.
- Use a dry cloth to clean the camera if it is dirty. In case the dirt is hard to remove, use mild detergent and wipe gently.
- Use caution when operating the camera in the vicinity of spot lights or bright lights, as well as light reflecting objects and surfaces.
- Take immediate action if ever the camera or RCU should become wet. Turn the power off and have the unit checked by an authorized service facility.
- Follow normal safety precautions to avoid personal injury.
- Use the camera in an environment where the temperature is within 14°F to 113°F (−10°C to +45°C), and the relative humidity is within 30 % to 90 %.
- Always turn the power off when the camera is not going to be used. Operate the camera and RCU only when there is adequate ventilation.



# MAJOR OPERATING CONTROLS AND THEIR FUNCTIONS

<Front View>

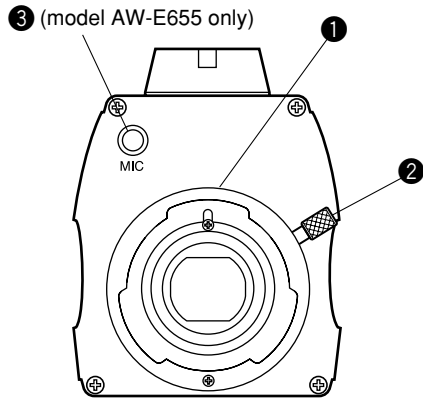

<Top View>

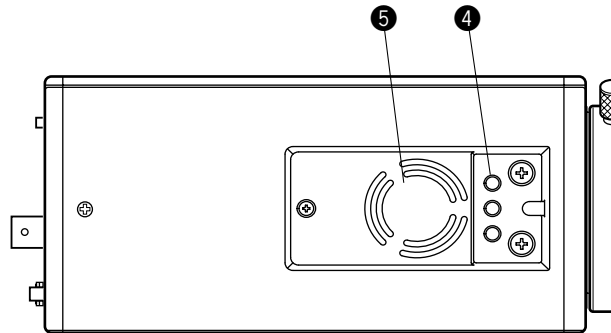

<Side View>

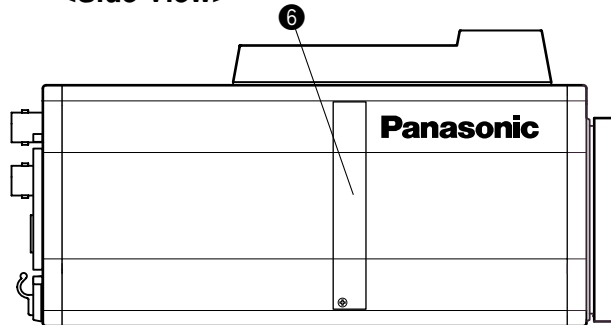

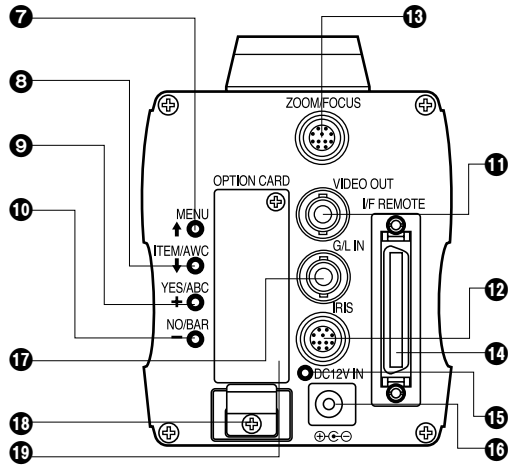

## 1. Lens Mount

2/3" Standard bayonet type (B4 mount) lens  
(AW-E750)

1/2" Standard bayonet type (B4 mount) lens  
(AW-E655, AW-E650)

1/3" C mount lens (AW-E350)

One of the lenses listed above or a microscope adaptor is installed on this mount.

## 2. Lens fixing ring knob

Rotate the lens fixing ring knob counterclockwise and remove the lens mount cap. Mount the lens on the camera and rotate the lens fixing ring knob clockwise in order to fix the lens securely.

## 3. Mic Jack (model AW-E655 only)

This is a  $\varnothing 3.5$  mm mic jack which supports PLUG IN POWER. Use the microphone which has more than  $1k\Omega$  of impedance, unbalanced.

## 4. Mounting hole

To install the camera on a wall or ceiling or to use a pan/tilt head or tripod, secure the unit using this screw hole (1/4"-20UNC) or using the accessory mounting adaptor.

## 5. Cooling Fan (models AW-E750, AW-E655 only)

The cooling fan can be set to "Auto" or "OFF" on the menu.

## 6. Expansion Slot

Remove the cover, and connect the expansion card box.

### 7. MENU Switch (MENU/ ↑)

A menu will appear on the monitor screen when this switch is pressed for about 5 seconds. This item can be selected by pressing the switch while the menu is on the screen.

### 8. ITEM/AWC Switch (ITEM/AWC/ ↓)

The item just below can be selected by pressing this switch while the menu is on the screen. When the menu is not displayed or the camera is in shooting mode, the automatic white balance control can be set with this switch.

### 9. YES/ABC Switch (YES/ABC/+)

The Sub Menu for each item of the Main Menu is displayed when this switch is pressed while the Main Menu is on the screen.

While the Sub Menu is displayed, any setting can be brought up to a higher value with this switch. When the menu is not displayed or the camera is in shooting mode, the automatic black balance control can be set with this switch.

### 10. NO/BAR Switch (NO/BAR/-)

The item just below can be selected by pressing this switch while the Sub Menu is on the screen.

While the Sub Menu is displayed any setting can be brought down to a lower value with this switch. When the menu is not displayed or the camera is in shooting mode, the color bar and the shooting conditions are indicated by pressing the switch.

### 11. Video Output Connector (VIDEO OUT)

A composite video signal is provided at this connector.

### 12. Iris Connector (IRIS)

Input terminal for lens with an iris control function.

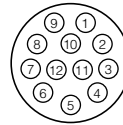

Pin No.	Signal	Pin No.	Signal
1	Return Control	7	Iris Follow
2	Not Used	8	Auto/Remote Control
3	GND	9	Not Used
4	Auto/Manual Control	10	Not Used
5	Iris Control	11	Not Used
6	Lens Power	12	Not Used

### 13. Zoom/Focus Connector (ZOOM/FOCUS) (model AW-E655 only)

This connector is for the remote cable of the lens and is a standard input connector for lenses with remote functions for zooming and focusing. When the camera is to be mounted on a Panasonic pan/tilt head (such as the AW-PH300A), do not use this connector — connect the remote cable of the lens to the LENS I/F connector on the pan/tilt head instead.

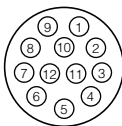

Pin No.	Signal	Pin No.	Signal
1	Focus Mode Position/Speed /Auto Focus	7	Signal Control (+5.0 V)
2	Zoom Mode Position/Speed	8	Focus Control
3	GND	9	Zoom Control
4	Iris Remote/Camera	10	Iris Mode Position/Speed
5	Iris Control	11	+V (+7.5 V)
6	Lens Power	12	-V (+2.5 V)

#### 14. I/F Remote Connector (I/F REMOTE)

Input terminal dedicated to control signals from the optional Remote Control Box (RCB) (such as the WV-CB700A) and the RCU (such as the WV-RC700A, WV-RC550) and the camera pan/tilt unit (such as the AW-PH300A).

- WV-CB700A is connected through the optional RCB cable (AW-CA50T10/AW-CA50B10).
- WV-RC700A/WV-RC550 is connected through the optional RCU cable (AW-CA50A26).
- AW-PH300A is connected through the optional pan/ tilt unit cable (AW-CA50T15/AW-CA50A15).
- Use the camera/pan-tilt head connecting cable (AW-CA50T29/AW-CA50C29) to connect the AW-PH350 to the convertible camera.

#### 15. Power Indicator

Red LED lamp lights to indicate that the specified DC power is supplied to the camera.

#### 16. DC 12 V Input Connector (DC 12V IN)

12 V DC is supplied through the optional DC power supply cable (AW-CA4T1).

(Recommended AC adaptor: AW-PS505)



#### Cautions

1. Connect this to a DC 12 V class 2 power supply only.
2. To prevent fire or shock, the UL listed wire VW-1, style 1007 should be used as for the cable for DC 12 V Input Connector.

#### 17. G/L Input Connector (G/L IN)

Signals synchronized with the reference signal are to be supplied to this connector when the camera is to be synchronized with the reference signal BB.

#### 18. Cable Clamp

Clamp the DC Power Supply Cable (AW-CA4T1) connected to the DC 12 V Input Connector to prevent it from slipping out.

#### 19. Optional Card Slot

Slot for inserting an optional card. For details, refer to the manual for optional cards.

# MOUNTING

## 1. Lens Mounting

### AW-E750, AW-E655, AW-E650

- Use the lens extension cable AW-CA12T12A (6"/15 cm) if your lens cable is too short.

Rotate the lens fixing ring knob counterclockwise and remove the lens mount cap. Mount the lens on the camera and rotate the lens fixing ring knob clockwise in order to fix the lens securely. Connect the camera cable to the IRIS connector on the back panel of the camera.

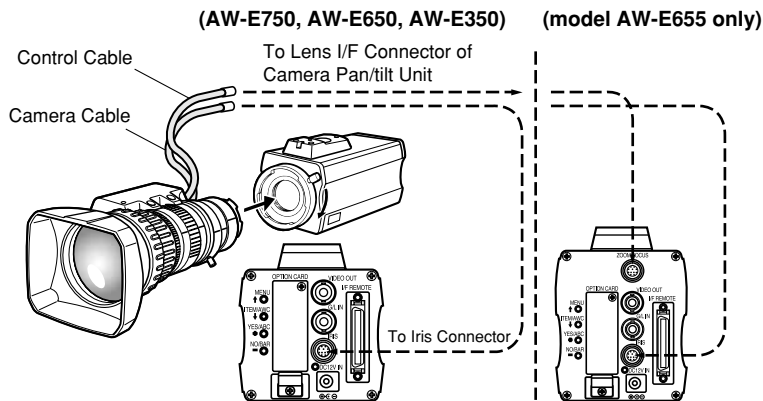

### AW-E350

- A 1/3-inch C mount type of lens can be used. Be absolutely sure that a lens whose mount threads extend no more than 4.3 mm from the lens mount surface is used. Use of any other kind of lens may damage the camera unit.

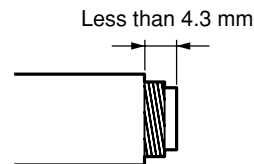

- Some lenses need to be attached in a different way. Therefore, reference should also be made to the operating instructions that accompany the lens.

Remove the lens mount cap, align the lens with the thread ridges on the lens mount and screw it securely into place.

Connect the lens cable to the IRIS connector.

## 2. Camera Mounting

### 1. AW-E750 or AW-E655 models:

Use the screws provided to attach the accessory mounting adaptor to the bottom panel of the camera.

### AW-E650 or AW-E350 models:

Use the screws provided to attach the accessory mounting adaptor to the top or bottom panel of the camera.

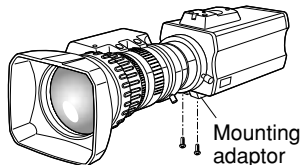

Use a screwdriver or similar to tighten the screws to secure the mounting adaptor. Make sure that the mounting adaptor is attached the right way round.

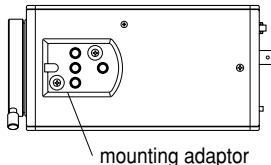

2. Fix the camera mounting base, pan/tilt unit, and tripod securely in the screw hole (1/4-20UNC) of the camera or the mounting adaptor.
3. If the camera cannot be securely fixed, mount the camera on a mounting bracket or the like with the supplied rubber sheet between the camera and it.
4. To mount the camera on the pan/tilt head, use a driver in order to fix it securely.

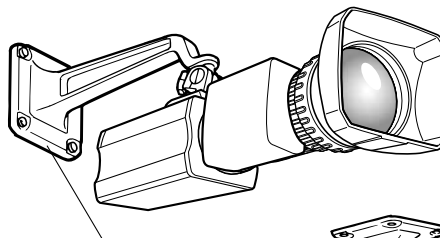

Camera Mounting Bracket (WV-831)

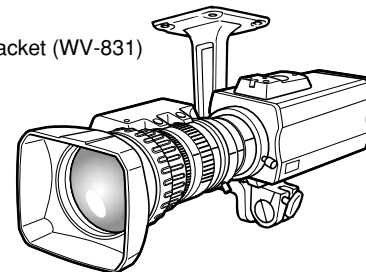

### ■ Preventing the camera from falling or coming off

- When attaching a camera to the pan/tilt head (AW-PH300A, AW-PH350), follow the directions in the Operating Instructions to fix the camera firmly in position. In addition, link the camera to the pan/tilt head using the safety chain and the mounting screws to help ensure the camera does not fall.
- When attaching the camera on any mounting or other pan/tilt head, check that the mounting can safely bear the total weight of the camera, lens, connection cables, etc., fix the camera firmly in position using the prescribed tool, and take appropriate measures to prevent the camera from falling.

# FLANGE BACK ADJUSTMENT (FOR ZOOM LENS)

## **AW-E750, AW-E655, AW-E650**

This adjustment will bring the subject into focus across the whole range from the maximum telephoto position to the widest angle position of the zoom lens.

1. Fully open the iris by shooting a dark object. (Iris selection switch should be set to M.)
2. Loosen the flange back lock knob.
3. Aim the camera at any object over 2 meters away from the camera.
4. Set the lens to its TELE end first and adjust its focus with the focus ring.
5. Set the lens to its widest angle next and adjust its focus with the flange back adjust ring.
6. Adjust the focus ring and the flange back adjust ring alternately for the best focus within the zooming range.

Tighten the flange back lock knob upon completion of focusing.

7. Turn the iris selection switch to Position A.

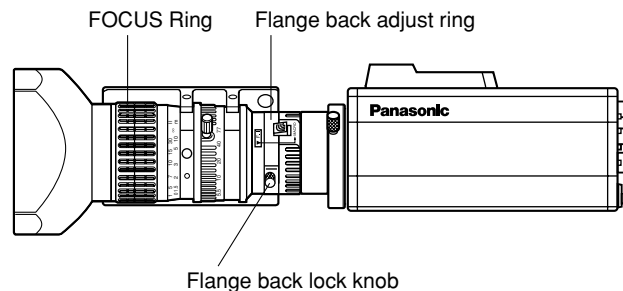

**AW-E750, AW-E655, AW-E650**

## AW-E350

This adjustment will bring the subject into focus across the whole range from the maximum telephoto position to the widest angle position of the zoom lens.

Perform this adjustment when back focusing is not achieved with a fixed focus lens.

(Adjustment range:  $\pm 0.2$  mm)

1. Fully open the iris by shooting a dark object.
2. Aim the camera at any object over 2 meters away from the camera, remove the cap over the camera's flange back adjust screw, and loosen the LOCK screw.
3. Set the lens to its TELE end first and adjust its focus with the focus ring.
4. Set the lens to its widest angle next and turn the FOCUS screw to adjust its focus.
5. Adjust the focus ring and FOCUS screw alternately for the best focus within the zooming range. Tighten the LOCK screw upon completion of the focusing.

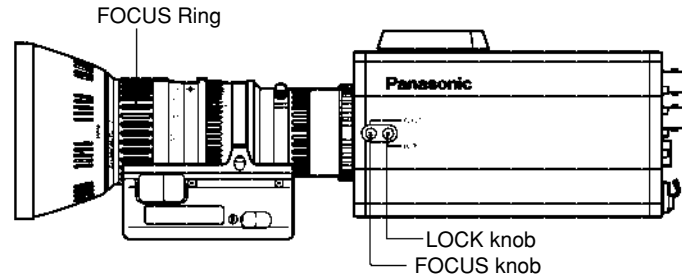

**AW-E350**



# IRIS GAIN CONTROL IN A LENS

An iris gain control hole is usually provided in the front of the lens. Adjustment of the iris gain, with a screwdriver through the hole may be done as follows. (Shape and location of the hole may vary depending on the type of lens.)

1. Turn the iris selection switch to Position A (AUTO).
2. Rotate the iris gain control to the maximum gain, but in a range where no hunting or oscillating of the iris ring develops.

Iris gain control (G, S)

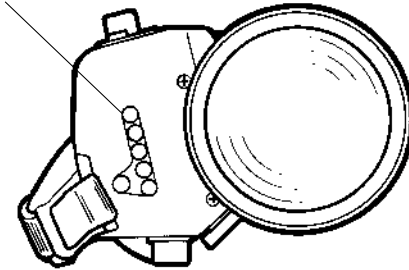

**Automatic iris power zoom lens**

# CONNECTIONS

## Caution:

The connection and installation should be done by qualified service personnel or system installers.  
Refer any servicing to qualified service personnel.

## ■ CONNECTION OF DEVICE WITH A COMPOSITE INPUT CONNECTOR

- Connection to any device which has a composite input connector, such as a video monitor or a VTR, must be made through the VIDEO OUT Connector.
- Power supply to the camera must be through the optional DC power supply Cable AW-CA4T1.
- For DC power supply, use the optional AC adaptor AW-PS505.

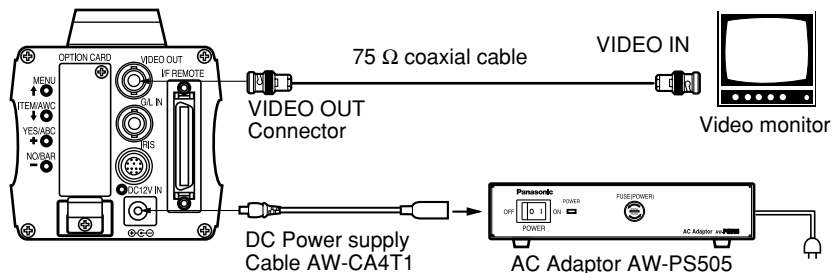

## ■ CONNECTION OF A REMOTE CONTROL UNIT (RCU)

Connection to the RCU (WV-RC700A, WV-RC550) is made through the optional RCU cable AW-CA50A26.

1. Turn RCU power off before connecting cables.
2. Set the cable selection switch of the RCU to MULTI (in case of using the WV-RC700A)
3. Connect the 50-pin connector of the RCU cable to the I/F REMOTE Connector of the camera.
4. Turn RCU power on and the power indicator lamp will light. The camera can now be remote controlled by the RCU.

### Notes:

- The maximum extension distance between the camera and WV-RC700A is 300 m. The maximum extension distance between the camera and WV-RC550 is 100 m.
- Use the following options for cable extension.

Studio Cable	WV-CA26U15 (15 m/50 ft)
	WV-CA26U30 (30 m/100 ft)
	WV-CA26U100 (100 m/330 ft)

Cable Joint Adaptor  
WV-CA26T26

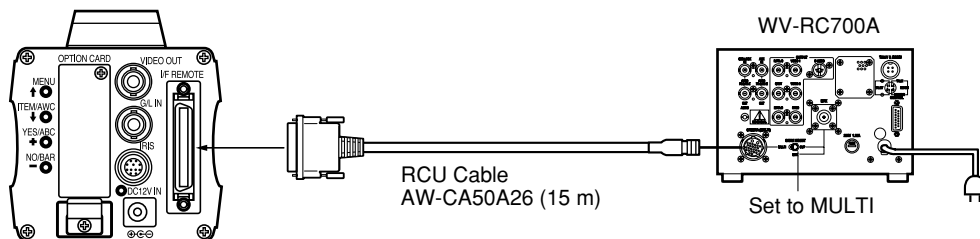

## ■ CONNECTION OF A REMOTE CONTROL BOX (RCB)

The RCB (WV-CB700A) and the camera must be connected with the optional RCB cable AW-CA50T10.

1. Turn RCB power off before connecting cables.
2. Connect the 50-pin connector of the RCB cable to the I/F REMOTE connector of the camera. The 10-pin connector must be connected to the RCB.
3. Turn RCB power on and the camera can be controlled remotely by the RCB.

### Notes:

- The monitor output signals of the RCB attenuate and deteriorate with cable length. It is recommended that the signals from the monitor output be used for monitoring purposes only.
- No gen-lock signal is available from the RCB.
- If a longer distance (more than 3 m) is desired between the camera and the RCB, use the following optional cable.

AW-CA50B10 and WV-CA10B02 (2 m)

WV-CA10B25 (25 m)

WV-CA10B50 (50 m)

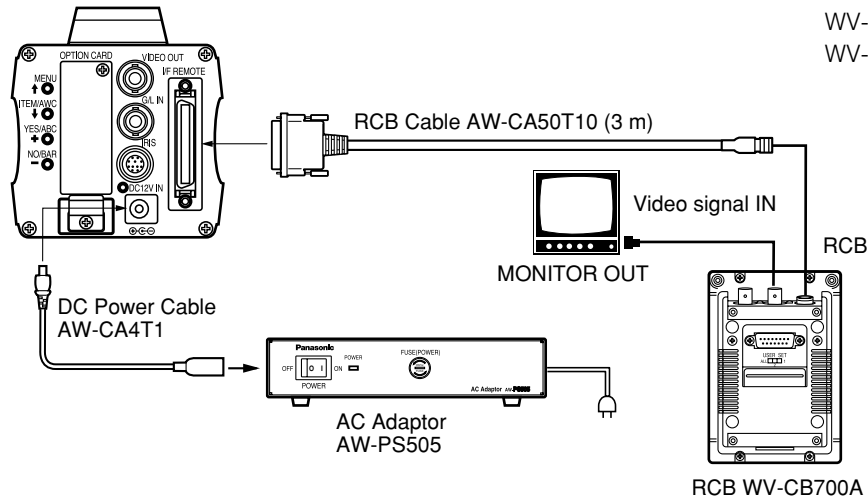

## ■ CONNECTION WITH MULTIPLE CAMERAS (COLOR LOCK MODE)

- An example of connection for VBS/BB input (Color lock mode).
- One of the multiple cameras is used as the source of reference signals.
- Supply a synchronizing signal (BB) to the G/L Input Connectors of each cameras.
- Do not switch off the camera used for supplying the reference signals.
- Adjust the SC-phase and H-phase at the Video Output Connector.

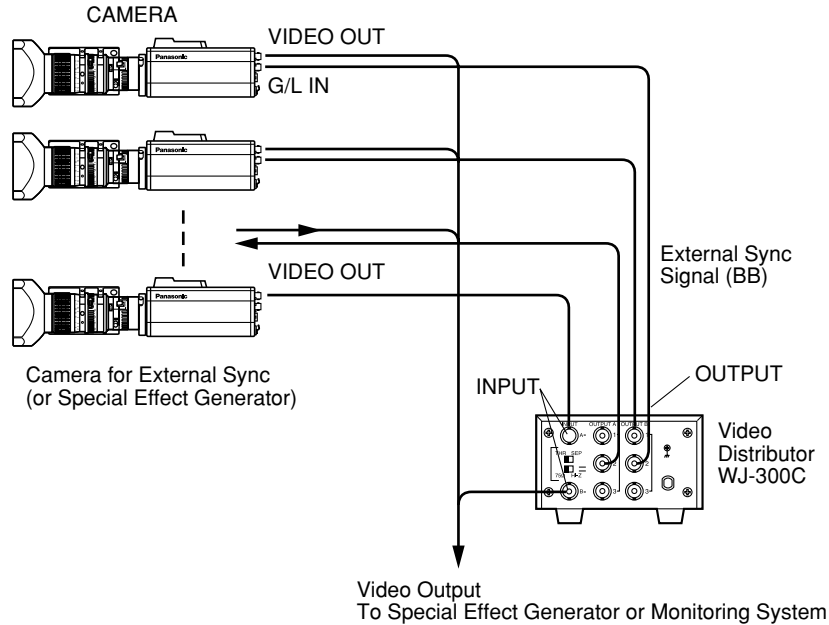

## ■ CONNECTION OF COMPUTER

The AW-CA50T9 PC control cable is required to control the camera using a computer. Consult your dealer for details. The user is responsible for providing the software used to control the camera.

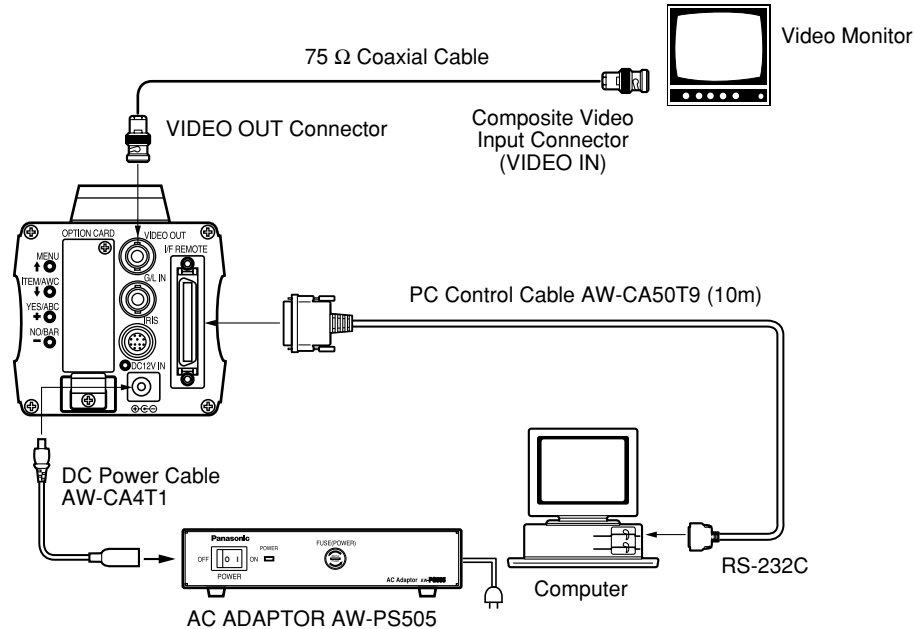

## ■ CONNECTION OF DEVICES WITH CAMERA PAN/TILT CONTROL SYSTEM

- Refer to the operating instructions of the pan/tilt head to connect camera to it.

# ADJUSTMENT

## ■ AUTOMATIC WHITE BALANCE CONTROL (AWC)

There are two white balance memories, “AWC A” or “AWC B” for two different light sources color temperatures, with the automatic white balance setting. Then, when the two different light sources are encountered, you may operate the camera properly by simply change the white balance mode to either AWC A or AWC B. There is no need to readjust the camera to the ambient conditions.

\* The preset conditions will be renewed whenever you input new conditions.

1. Turn the white balance selection switch to either “AWC A” or “AWC B” of RCU or select the white balance mode either AWC A or AWC B by menu.
2. Aim the camera at a white object (a white wall or a white handkerchief) and zoom in to enlarge the image as much as possible.

[ADJUSTMENT by CAMERA]

3. In normal shooting mode:  
Press the ITEM/AWC switch for over 2 second.

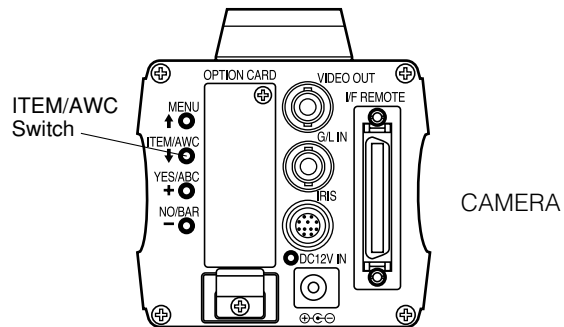

[ADJUSTMENT with the RCU (RCB, Hybrid control panel)]

4. When the AUTO set switch is turned to AWC, the white balance will be automatically set. While the system is being set, auto warning indicator (LED) blinks and it goes out when the white balance setting is completed. If the lamp remains lit, the setting must be tried again.

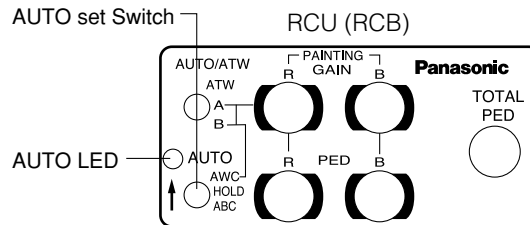

**Notes:**

- For white balance setting aim the camera at a white object and try to position it in the center of the monitor screen. The object must appear in over 10 % of the total monitor screen area. Try to avoid overly bright objects in the scene.
- White balance may not be correctly set if the lighting of the object is too weak.

The white object must occupy over 10 % of the monitor screen area.

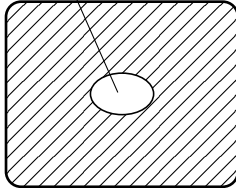

- Since the camera has a built-in memory, the set white balance will remain in the memory even if power is turned off. Therefore, it is not necessary to reset the white balance if the color temperature of those objects remains unchanged. However, it must be reset if the color temperature changes, such as when you move from indoors to outside, or vice versa.
- When the camera is used without a RCU or RCB red/blue gain adjustment of painting setting will be automatically reset to  $\pm 0$  after setting the white balance. (painting setting in only USER MODE.)

## ■ AUTOMATIC TRACKING WHITE BALANCE SETTING (ATW)

White balance will be automatically set to continuously match changes of light source and color temperature while the white balance setting is set to ATW.

- Notes:**
- ATW might not function properly when high brightness light (ex. fluorescent lamp) beams into a screen.
  - White balance may not be accurately set if there is no white object in the scene being shot.

## ■ MANUAL WHITE BALANCE SETTING

[ADJUSTMENT by CAMERA]

Manual setting is possible in USER MODE only.

1. Select the white balance mode either AWC A or AWC B by menu.
2. Aim the camera at a large white object. Press the ITEM/AWC switch for over 2 second.
3. Adjust the red gain/blue gain control in the PAINTING item of Color Set sub menu of USER MODE until the carrier wave of the white portion of the video signal is at the minimum width or the white object in the monitor screen appears pure white. (Use an oscilloscope or a waveform monitor for precise adjustment.)

[ADJUSTMENT with the RCU (RCB)]

After AWC setting, adjust the R/B GAIN controller in the same way as described in Step 3 above.



Minimize the carrier wave using the red & blue gain controls

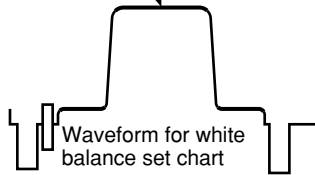

## ■ RESET TO 3 200K OR 5 600K WHITE BALANCE

When the white balance setting is set to either “P SET 3 200K” or “P SET 5 600K” the white balance will be automatically set to the color temperature 3 200K or 5 600K, respectively.

## ■ BLACK BALANCE ADJUSTMENT

- Close the lens.  
If the motor drive lens is controlled from the camera, the lens is automatically closed when the black balance is adjusted.
- When the camera is used without a RCU or RCB, R/B pedestal adjustment of painting setting will be automatically reset to  $\pm 0$  after setting the black balance. (painting setting in only USER MODE.)

[ADJUSTMENT by CAMERA]

Press the YES/ABC switch for over 2 seconds and the black balance will be set automatically in 10 seconds.

In user mode, black balance fine adjustment can be performed with the red pedestal/blue pedestal setting after setting the black balance.

[ADJUSTMENT with the RCU (RCB, Hybrid control panel)]

Set the AUTO set switch to ABC and the black balance will be automatically set. While the system is being set, the auto warning indicator (LED) blinks and it goes out when the black balance setting is completed. If the lamp remains lit, ABC should be tried again.

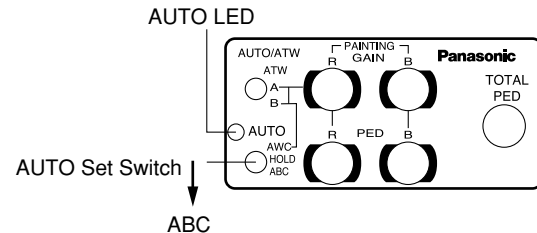
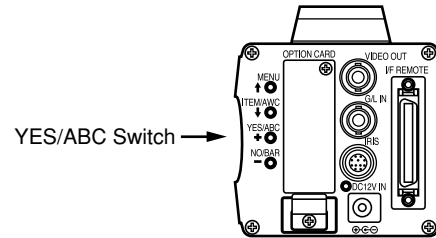

## ■ TOTAL PEDESTAL LEVEL ADJUSTMENT

(Use an oscilloscope or a waveform monitor for this adjustment.)

This step is to adjust the black levels (pedestal levels) of two or more cameras to be the same.

[ADJUSTMENT by CAMERA]

1. Close the lens.
2. Select Pedestal item in the brightness setting Sub Menu (Select [Pedestal] in the [Iris, Shutter, Gain Set] sub menu in USER MODE.)
3. Set the pedestal level to 5 IRE (0.035 V) with the YES/ABC switch or the NO/BAR switch.

[ADJUSTMENT with RCU (RCB, Hybrid control panel)]

Adjust the pedestal level to 5 IRE with the total pedestal adjustment.

<b>**Brightness Set**</b>	
Picture Level	±0
Light PEAK/AVG	0
Light Area	Top Cut
Auto ND (ELC)	(OFF)
Auto Gain Up	(OFF)
AGC Max Gain	(---)
Manual Gain Up	(0dB)
Digital Gain Up	0dB
Charge Time	OFF
Pedestal	(±0)
Return	

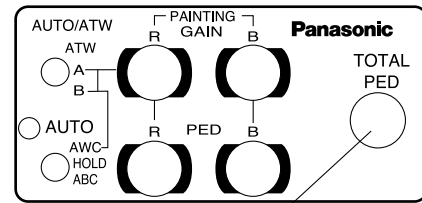
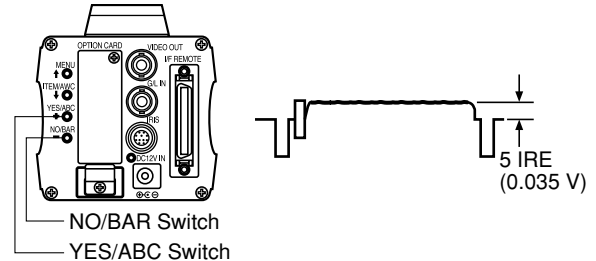

## ■ GEN-LOCK ADJUSTMENT

Phase adjustments must be performed with the camera or the RCU (RCB) when external synchronizing signals are supplied to the system in cases where multiple cameras are used or peripheral devices are connected.

### ● HORIZONTAL PHASE CONTROL

Observe the waveform of the external synchronizing input signal (black burst signal) and video output signal on a two-channel oscilloscope. Then match the horizontal phase of both signals by adjusting them with the cameras or RCU's horizontal phase control.

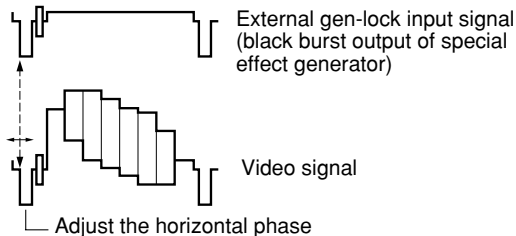

[ADJUSTMENT by CAMERA]

1. Press the NO/BAR switch for over 5 seconds to display the color bar.
2. Select [G/L Adjustment] on the main menu, then select [H PHASE] on the submenu.
3. Adjust the horizontal phase with the YES/ABC and NO/BAR switch.

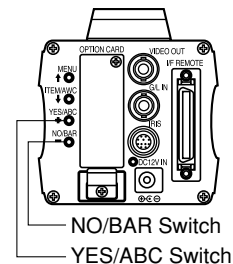
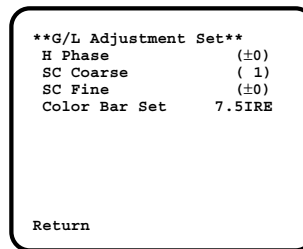

[ADJUSTMENT with RCU (RCB, Hybrid control panel)]  
Use the horizontal phase control.

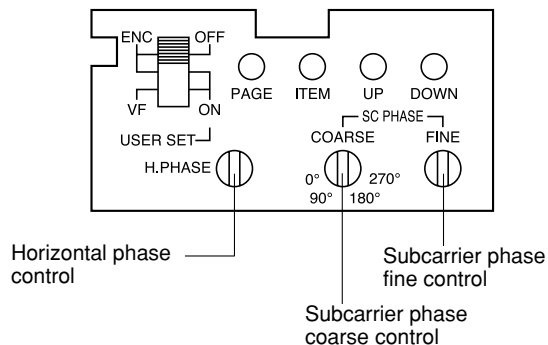

**CAUTION:**

When horizontal phase adjustment is required using RCU (RCB) or Hybrid Control Panel, BAR/CAM switch should be set to BAR. Horizontal phase cannot be adjusted if the switch is in the CAM position. After adjustment set BAR/CAM switch back to CAM.

● **COLOR PHASE ADJUSTMENT**

Supply the output signal (split color bar) from the color special effect generator to a color monitor or vectorscope. Adjust the color phase of the camera.

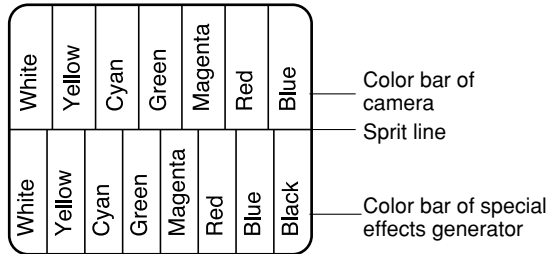

[ADJUSTMENT by CAMERA]

1. Press the NO/BAR switch for over 5 seconds for the color bar mode.
2. Select [G/L Adjustment] on the main menu, then select [SC Coarse] on the sub menu.
3. Make coarse adjustment with the YES/ABC switch and the NO/BAR switch.

4. Select [SC Fine] on the sub menu. Perform fine adjustment with the YES/ABC switch and the NO/BAR switch.

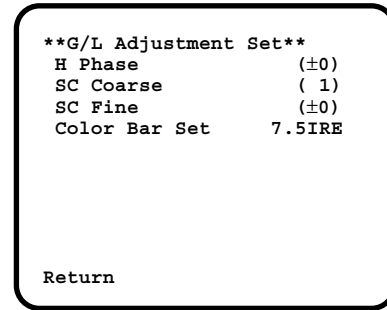

[ADJUSTMENT with RCU (RCB, Hybrid control panel)]

Use the subcarrier phase coarse adjustment control and subcarrier phase fine control.

\* It is recommended that a vectorscope be used for maximum accuracy in color phase adjustment.

**CAUTION:**

When color phase adjustment is required using RCU (RCB) or Hybrid Control Panel, BAR/CAM switch should be set to BAR. Color phase cannot be adjusted if the switch is in the CAM position. After adjustment set BAR/CAM switch back to CAM.

# USE MODE SETTING

## ■ Use Mode Setting

The camera has four use modes, and various functions for four use modes have been preset.

Functions can be set as best suited to each use mode.

- Halogen mode  
Suited to indoor shooting, such as at weddings, parties, lecture meetings, events, etc.  
Settings can be changed using a simple menu.
- Fluorescent mode  
Suited to indoor shooting under fluorescent lighting.  
Settings can be changed using a simple menu.
- Outdoor mode  
Suited to outdoor shooting.  
Settings can be changed using a simple menu.
- User mode  
Settings can be changed using a detail menu.

## ■ SETTING BY CAMERA

1. Turn the camera on while keeping the MENU switch depressed.  
The use mode setting menu shown at right appears on the monitor screen and one of the use mode blinks.

2. Press the MENU switch, ITEM/AWC switch, or NO/BAR switch to let the desired use mode blink.  
MENU switch (↑): The blinking item moves up by one.  
ITEM/AWC switch (↓), NO/BAR switch (-): The blinking item moves down by one.

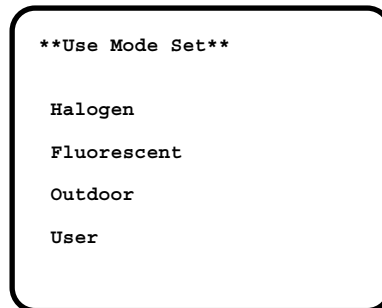

3. Press the YES/ABC Switch.  
The blinking use mode comes into effect. After the use mode setting menu is shown for about 5 seconds, the camera returns to be ready for operation. Then, the camera operates in the selected use mode.

## ■ SETTING BY RCU (RCB) OR HYBRID CONTROL PANEL

An operation mode is selected depending on the position of the scene file switch.

Operation mode	Scene File Switch Position of RCU (RCB)	Scene File Switch Position of Hybrid control panel
Halogen Mode	1	1
Fluorescent Mode	2	2
Outdoor Mode	3	3
User's Mode	USER SET	4

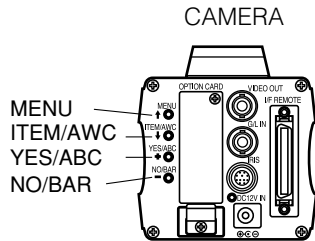

RCU (RCB)

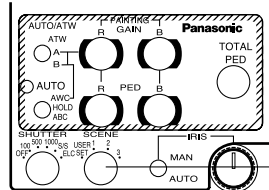

SCENE FILE Switch

Hybrid Control Panel

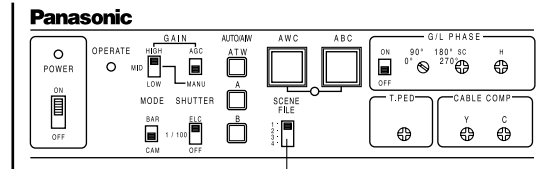

SCENE FILE Switch

# MENU ITEM SETTING

## ■ MENU ITEM SETTING

- Each of the four use modes of the camera has a main menu. (Shown at right)
- Each item of the main menu has a submenu, which consists of several settings.
- These settings have been preset to the optimum values to suit each use mode, and can be changed to suit actual shooting conditions.
- They can be set from the camera and RCU (RCB). They can also be set from the hybrid control panel using the switches, but the setting items are limited because the menu is not shown.

## ● MAIN MENU SCREEN

Main Menu of Halogen,  
Fluorescent, Outdoor Mode

Main Menu of User Mode

```
**Halogen Mode Set**  
Brightness Set  
Color Set  
G/L, Color Bar Set  
Sharpness(DTL) Set  
Other Set  
(Option Card Set)  
  
Initialize Data  
  
(End)
```

```
**User Mode Set**  
Iris, Shutter, Gain Set  
Color Set  
G/L, Color Bar Set  
Detail Set1 Detail Set2  
Color Matrix Set  
Other Set1 Other Set2  
(Option Card Set)  
  
Initialize Data  
  
(End)
```

Blinking

Use Mode

### Notes:

- Composite signals are output from the video output regardless of the position ENC/VF of the RCU (RCB) user set switch.
- [End] is displayed only in setting from the camera alone.
- [Option Card Set] is shown only when an optional card is inserted.

\* When the color bar signal is output from camera, "G/L, Color Bar Set" is displayed.

```
**G/L Adjustment Set**  
H Phase (±0)  
SC Coarse ( 1)  
SC Fine (±0)  
Color Bar Set 7.5IRE  
  
Return
```

## ■ SETTING

### 1. From the camera alone:

Keep the MENU switch depressed for 5 seconds or more.

### From RCU (RCB):

Set the user set switch in the pocket to the ON position.

The main menu appears on the monitor screen.

- Each time the MENU switch (↑), ITEM/AWC switch (↓), or NO/BAR switch (–) is pressed, the blinking item moves up or down.
- When the YES/ABC switch is pressed after selecting the desired item to blink, the submenu for the selected item appears on the screen.
- Select the desired item to be changed in its settings using the the MENU switch (↑) and ITEM/AWC switch (↓).
- Press the YES/ABC switch (+) or NO/BAR switch (–) to change the settings.
- Select [Return] using the MENU switch and ITEM/AWC switch, then press the YES/ABC switch to return to the main menu.
- After changing the settings, take the following steps.

**Camera alone:** Select [End] using the MENU switch and ITEM/AWC switch and press the YES/ABC switch.

**RCU (RCB):** Set the user set switch in the pocket to the OFF position.

The camera will now operate according to the new settings.

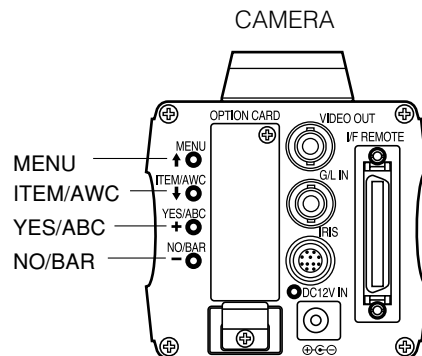

### RCU (RCB)

#### USER SET SWITCH

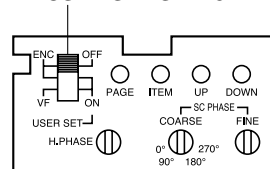



## ■ SUB MENU (Halogen Mode, Fluorescent Mode, Outdoor Mode)

### ① Brightness Set Display

```

**Brightness Set**
1---- Picture Level      ±0
2---- Light PEAK/AVG    0
3---- Light Area        Top Cut
4---- Auto ND(ELC)      (OFF)
5---- Auto Gain Up      (OFF)
6---- AGC Max Gain      (---)
7---- Manual Gain Up    (0dB)
8---- Digital Gain Up   0dB
9---- Charge Time       OFF
10--- Pedestal          (±0)
      Return
  
```

### ③ G/L Adjustment Set Display

```

**G/L Adjustment Set**
1---- H Phase           (±0)
2---- SC Coarse         ( 1)
3---- SC Fine           (±0)
4---- Color Bar Set     7.5IRE
      Return
  
```

### ⑤ Other Set Display

```

**Other Set**
1---- Contrast(Gamma)   Mid
2---- Shutter Speed    (OFF)
3---- Synchro Scan     ---
4---- V Resolution     Normal
5---- Baud Rate        9600bps
6---- Component        Y/Pr/Pb
7---- Digital Extender OFF
8---- Fan              Auto
9---- Auto Focus       OFF
10--- Filter           Normal
      Return
  
```

### ② Color Set Display

```

**Color Set**
1---- Chroma Level      ±0
2---- Flesh Tone        ±0
3---- White Bal         (AWC A)
4---- ATW Speed         ---
5---- Nega/Posi        Posi
      Return
  
```

### ④ Sharpness (DTL) Set Display

```

**Sharpness (DTL) Set**
1---- DTL Select       Sharpness
2---- Level            (High)
3---- Noise Suppress   OFF
4---- Clean DNR        OFF
5---- 3D-DNR           OFF
6---- DTL Flesh Tone   Mid
      Return
  
```

- Settings enclosed in parentheses can be set with the RCU (RCB) switch or VR in RCU (RCB) mode.
- To return to the initial settings, refer to page 56.

## ■ Setting and Changing of the Setting (Halogen Mode, Fluorescent Mode, Outdoor Mode)

### ① Brightness Set Display

#### 1. Video Level Adjustment [Picture Level: -50 to +50]

Convergence level of AUTO IRIS/AUTO GAIN UP/AUTO ND (ELC) can be adjusted.

#### 2. Detecting Ratio Adjustment [Light PEAK/AVG: P50 to A50]

The ratio of AUTO IRIS/AUTO GAIN UP/AUTO ND (ELC) detected peak to average can be adjusted within a predetermined range.

#### 3. Photometric Measurement Method Setting

##### [Light Area: All, Center, Top cut, BTM cut, R/L cut]

A photometric measurement method can be selected for AUTO IRIS/AUTO GAIN UP/AUTO ND (ELC).

**All:** All the screen area is measured.

**Center:** The screen is measured mainly in the center area, about one-third of both the top and bottom and one-third of both the right and left portions of the screen are excluded from measurement.

**Top cut:** About one-third of the top part of the screen is excluded from measurement.

**BTM cut:** About one-third of the bottom portion of the screen is excluded from measurement.

**R/L cut:** About one-third of both the right and left portions of the screen are excluded from measurement.

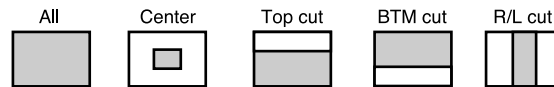

#### 4. Auto ND (ELC) Setting [Auto ND (ELC): ON, OFF]

This cannot be set unless either “OFF” or “Auto” has been set for the CCD storage time setting (①-9).

**ON:** The electronic shutter is controlled to automatically adjust the luminance.

**OFF:** Luminance is not automatically adjusted by the electronic shutter.

#### Notes

- ON is automatically selected when the electronic shutter (⑤-2) on the submenu [Other Set] is set to [Auto ND]. OFF is selected when other than [Auto ND] is selected.
- ON is selected when the SHUTTER switch is set to [ELC] in RCU (RCB) mode, and OFF is selected when it is set to other than [ELC].

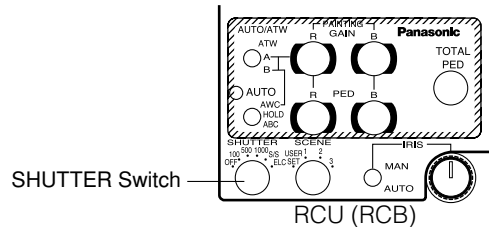

## 5. Auto Gain Up Control Setting

[Auto Gain Up: OFF, ON]

This cannot be set when “Auto” has been set for the CCD storage time setting (①-9).

**OFF:** The light quantity is not adjusted automatically.

**ON:** The light quantity is adjusted automatically. The maximum to which the gain can be increased using the auto gain up function is selected by the AGC maximum gain setting (①-6).

### Notes

- In case of settings on the camera alone or when the iris switch on the RCU (RCB) is at [AUTO], the Auto Gain Up control may not operate if the lens iris switch is in the manual position.
- When the AGC switch on the hybrid control panel is set to AGC, the Auto Gain Up control operates in the HIGH position.

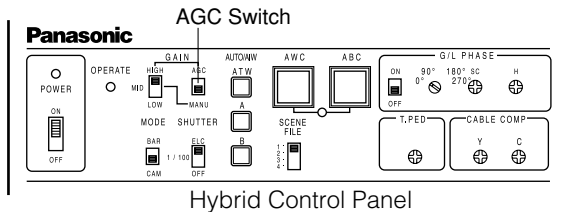

## 6. AGC Maximum Gain

[AGC Max Gain: 6dB, 12dB, 18dB, 24dB, N/Eye L, N/Eye H] (AW-E750, AW-E655, AW-E650)

[AGC Max Gain: 6dB, 12dB, 18dB, 24dB, N/Eye] (AW-E350)

This is used to set the maximum amount to which the gain can be increased when “ON” has been selected as the auto gain up setting (①-5).

## 7. Manual Gain Up Control Setting

[Manual Gain Up: 0 dB to 30 dB, N/Eye L, N/Eye H] (AW-E750, AW-E655, AW-E650)

[Manual Gain Up: 0 dB to 30 dB, N/Eye] (AW-E350)

Manual setting is possible only when the Auto Gain Up control (①-5) is in the OFF position.

**0 dB:** 0 dB should be selected in normal cases.

**1 dB to 30 dB:** Use this range if sufficient video output cannot be obtained even when the lens iris is opened in shooting dark scenes.

### AW-E750, AW-E655, AW-E650

**Night Eye L:** Use this setting if it is not possible to achieve a satisfactory video output even at 30 dB.

**Night Eye H:** Use this setting if it is not possible to achieve a satisfactory video output even at the Night Eye L setting.

### AW-E350

**Night Eye:** Use this setting if it is not possible to achieve a satisfactory video output even at 30 dB.

## Notes

- Only 0 dB, 9 dB, or 18 dB can be selected in case of using the RCU (RCB).
- 0 dB when the manual GAIN switch on the hybrid control panel is at LOW, 9 dB when it is at MID, or 18 dB when it is at HIGH.

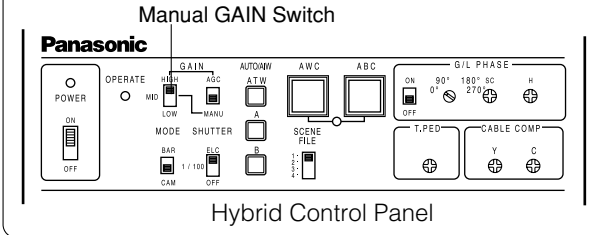

## 8. Digital Gain Up Setting

**[Digital Gain Up: 0dB, 6dB, 12dB, 18dB, 24dB, 30dB]**

This can be set only when "OFF" has been selected as the auto gain up setting (1-5).

**0 dB:** Under normal circumstances, this setting is used.

**6 dB to 30 dB:** Use this setting while shooting dark scenes if it is not possible to achieve a satisfactory video output even when the lens diaphragm is opened and "Night Eye" is selected as the manual gain up setting (1-7).

## 9. CCD Storage Time Setting

**[Charge Time: Auto, OFF, 1/30s, 1/15s, 1/8s, 1/4s, 1/2s, 1s, 2s]**

This is used to set the CCD storage time.

**Auto:** ALC is performed followed by AGC and then by the data storage, and the camera automatically adjusts the light quantity.

If "ON" is selected as the auto ND (ELC) setting (1-4), ELC is performed followed by ALC, AGC and then by the data storage in this order, and the light quantity is automatically adjusted.

The electronic shutter setting (5-2) cannot be changed.

**OFF:** Under normal circumstances, this setting is used.

**1/30s to 2s:** Use this setting if it is not possible to achieve a satisfactory video output even when the gain up setting is used.

The auto ND (ELC) setting (1-4) and electronic shutter setting (5-2) go "OFF" and cannot be changed.

\* If the images (CCD read out (mode) setting (5-4)) have been set to "Fine", 1/15s to 2s is selected as the storage time setting, and the sensitivity is set to about one-half of that obtained with when they have been set to "Normal".

## 10. Black Level Setting [Pedestal: -150 to +150]

The black level (pedestal) of the luminance (Y) signal can be set. Used in adjusting the black levels of two or more cameras.

## ② Color Set Display

### 1. Chroma Level Adjustment

**[Chroma Level: -3 to +3]**

Chroma Level can be decreased or increased to any of three levels each.

### 2. Skin Color Adjustment [Flesh Tone: -3 to +3]

Skin color can be decreased or increased to any of three levels each.

### 3. White Balance Setting

**[White Bal: ATW, AWC A, AWC B, P SET 3 200K, P SET 5 600K]**

**ATW:** The white balance is automatically adjusted to be always right.

**AWC A, AWC B:** Once the white balance is adjusted with the ITEM/AWC switch on the back of the camera, it is no longer necessary to set the white balance again if you simply select AWC A or AWC B, provided that the camera is used under the same conditions.

Fine color adjustment can be made after setting AWC by red/blue gain adjustment in user mode or from the RCU (RCB).

**P SET 3 200K:** The white balance is adjusted to 3 200K illumination.

**P SET 5 600K:** The white balance is adjusted to 5 600K illumination.

**Note**

Neither P SET 3 200K nor P SET 5 600K can be set from the RCU (RCB) or the hybrid control panel.

**4. ATW Speed Setting**

**[ATW Speed: SLOW 2, SLOW 1, MID, FAST 1, FAST 2]**

ATW Speed can be set.

**5. Negative/Positive Selection**

**[Nega/Posi: Posi, Nega]**

**Posi:** Normal image

**Nega:** Image is shown reversed in darkness and color.

**③ G/L Adjustment Set Display**

**1. Horizontal Phase Adjustment**

**[H Phase: -206 to +49]**

Horizontal phase can be adjusted when a genlock signal is supplied.

**2. Sub Carrier Phase Coarse Adjustment**

**[SC Coarse: 1, 2, 3, 4]**

Coarse adjustment of subcarrier phase can be made when a genlock signal is supplied.

**3. Subcarrier Phase Fine Adjustment**

**[SC Fine: -511 to +511]**

Fine adjustment of subcarrier phase can be made when a genlock signal is supplied.

**4. Color Bar Setup Setting**

**[Color Bar Set: 0.0 IRE, 7.5 IRE]**

The setup level of color bar can be adjusted.

## ④ Sharpness (DTL) Set Display

### 1. Detail Select Setting

#### [DTL Select: Sharpness, Super DTL]

If contour correction is not sufficient at the Sharpness position when Detail Level setting is set to LOW or HIGH, select the Super DTL position.

#### Note

Neither Sharpness nor Super DTL is valid for contour correction if Detail Level setting is in the OFF position.

### 2. Detail Level Setting [Level: OFF, LOW, HIGH]

Detail level can be adjusted when Detail Select setting is at Normal. Super DTL level can be adjusted when it is at Super DTL.

In case of using the RCU (RCB), the above can be adjusted with the contour correction switch (DTL).

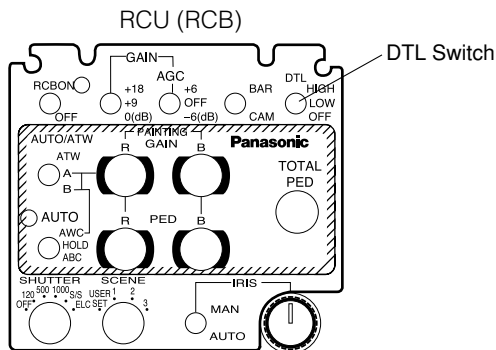

### 3. Noise Suppress Level Setting

#### [Noise Suppress: OFF, LOW, HIGH]

Screen noise can be reduced when Detail Level setting (④-2) is at HIGH or LOW.

### 4. Clean DNR Setting [Clean DNR: HIGH, LOW, OFF]

This enables the clean DNR effect to be selected.

### 5. 3D-DNR Setting [3D-DNR: OFF, Low, Mid, High]

This enables the 3D-DNR effect to be selected.

\* When “Mid” or “High” is selected, the noise is reduced but lag increases.

### 6. DTL Flesh Tone Setting

#### [DTL Flesh Tone: LOW, MID, HIGH]

**LOW:** The roughness of the flesh tones is minimized.

**MID:** This is the standard setting.

**HIGH:** The outline compensation for the flesh tones is accentuated.

## 5 Other Set Display

### 1. Contrast Adjustment

**[Contrast (Gamma): LOW, MID, HIGH]**

The contrast can be adjusted to any of three levels.

### 2. Electronic Shutter Setting

**[Shutter Speed: OFF, 1/100 to 1/10 000, S/Scan, Auto ND]**

**OFF:** Electronic shutter is turned off.

**1/100, 1/250, 1/500, 1/1 000, 1/2 000, 1/4 000, 1/10 000:**

Electronic shutter operates at one of these speeds as selected.

**S/Scan (Synchro Scan):** Electronic shutter operates at the speed set with the electronic shutter synchro-scan setting (5-1).

**Auto ND:** Electronic shutter is controlled to automatically adjust the luminance. (ELC)

#### Notes

- In case of using the RCU (RCB), none of the shutter speeds – 1/250, 1/2 000, 1/4 000, and 1/10 000 can be selected.
- In case of using the hybrid control panel, only OFF, 1/100, or Auto ND (ELC) can be selected.
- If the lens iris switch is at M (Manual) when operating the camera alone or when the iris switch on the RCU (RCB) is at AUTO, Auto ND may not function. Set the lens iris switch to A (Auto).
- Flickering may increase at Auto ND under fluorescent lights.
- Auto ND is automatically selected if Auto ND (ELC) setting is set to ON.

### 3. Electronic Shutter Synchro Scan Setting

**[Synchro Scan: 60.34Hz to 15.75kHz]**

This setting is possible only when Electronic Shutter setting (5-2) is at S/Scan.

Horizontal bar noise can be reduced by synchro-scan adjustment in shooting workstation scenes, for example.

✳ For luminance settings at each shutter speed and synchro-scan shutter speed, refer to the table below.

Shutter Speed	Synchro-scan	Required luminance ratio
OFF	—	1
1/100	100.3 Hz	2
1/250	250.0 Hz	4
1/500	492.2 Hz	8
1/1 000	984.4 Hz	16
1/2 000	1.969 kHz	32
1/4 000	3.938 kHz	64
1/10 000	7.875 kHz	160

### 4. CCD Read Out Mode Setting

**[V Resolution: Normal, Fine]**

**Normal:** Normal image. (CCD storage will be by field storage.)

**Fine:** Vertical resolution increases. (Vertical resolution is raised without increasing residual images by frame storage and Electronic shutter.)

Normal is recommended for general use because sensitivity will decrease at the Fine setting.



## 5. PC Control Access Speed Setting

**[Baud Rate: 1 200bps, 2 400bps, 4 800bps, 9 600bps]**

Select a communication speed in controlling the camera from the computer.

## 6. Component Output Setting

**[Component: RGB, Y/Pr/Pb, Y/C]**

This enables RGB, Y/Pr/Pb or Y/C to be selected as the component signals which are to be output from the I/F REMOTE connector.

## 7. Digital Extender Setting

**[Digital Extender: OFF, ON]**

**OFF:** Under normal circumstances, this setting is used.

**ON:** An extender effect which is approximately 1.5 times greater is achieved.  
However, the resolution drops when the digital extender is set to "ON".

## 8. Fan Setting [Fan: OFF, Auto]

**(models AW-E750, AW-E655 only)**

**OFF:** Select this setting to stop the fan when its operating sound is found to be bothersome in a studio or other such environment.

**Auto:** The temperature is detected automatically, and the fan starts operating when the temperature exceeds approx. 10°C in the storage mode or approx. 35°C in any other mode.  
Under normal circumstances, the "Auto" setting is used.

## 9. Auto Focus Setting [Auto Focus: OFF, ON] (model AW-E655 only)

This enables auto focus ON and OFF to be controlled when the zoom/focus cable of a Canon AF lens has been connected to the ZOOM/FOCUS connector on the AW-E655.

## 10. Filter Setting

**[Filter: IR Through, Normal, 1/16ND, 1/64ND]  
(model AW-E655 only)**

**IR Through:** The infrared shooting mode is established. Irradiate the subject with infrared light.

**Normal:** Under normal circumstances, this setting is used.

**1/16ND:** The 1/16 ND filter is inserted. Use this setting when the lens cannot be stopped down enough by the diaphragm.

**1/64ND:** The 1/64 ND filter is inserted. Use this setting when the lens cannot be stopped down enough by the diaphragm even at the 1/16ND setting.

## ■ Sub Menu (User Mode)

### ⑥ Iris, Shutter, Gain Set Display

```

**Iris,Shutter,Gain Set**
1---- Picture Level          ±0
2---- Light PEAK/AVG        ±0
3---- Light Area            Top Cut
4---- Auto Iris Adjust      OFF
5---- Shutter Mode          (Step)
6---- Step/Synchro          (OFF)
7---- Gain                  (0dB)
8---- Digital Gain Up       0dB
9---- AGC Max Gain          (---)
10--- Charge Time           OFF
      Return
  
```

### ⑧ G/L Adjustment Set Display

```

**G/L Adjustment Set**
1---- H Phase                (±0)
2---- SC Coarse              ( 1)
3---- SC Fine                (±0)
4---- Color Bar Set          7.5IRE
      Return
  
```

### ⑨ Detail Set Display

```

**Detail Set1**
1---- Detail                  (High)
2---- H Detail Level H       11
3---- V Detail Level H       6
4---- H Detail Level L       7
5---- V Detail Level L       3
6---- Detail Band            2
7---- Noise Suppress         3
8---- Level Dependent        0%
9---- Dark Detail            0
      Return
  
```

### ⑦ Color Set Display

```

**Color Set**
1---- Chroma Level           ±0
2---- White Bal              (AWC A)
3---- ATW Speed              Mid
4---- Pedestal               (±0)
   --- Painting
   |  R Gain                  (±0)
   |  B Gain                  (±0)
5---- R Pedestal             (±0)
   |  B Pedestal             (±0)
6---- Nega/Posi              Posi
      Return
  
```

```

**Detail Set2**
10--- Chroma Detail          0
11--- Flesh DTL Level        Mid
12--- Corner Detail          OFF
13--- Precision Detail       OFF
      Return
  
```

- Settings enclosed in parentheses can be set with the RCU (RCB) switch or VR in RCU (RCB) mode.
- To return to the initial settings, refer to page 56.

## ⑩ Color Matrix Set Display

### \*\*Color Matrix Set 1\*\*

B_Mg Gain	±0
B_Mg Phase	±0
Mg Gain	±0
Mg Phase	±0
Mg_R Gain	±0
Mg_R Phase	±0
R Gain	±0
R Phase	±0

### \*\*Color Matrix Set 2\*\*

R_Yl Gain	±0
R_Yl Phase	±0
Yl Gain	±0
Yl Phase	±0
Yl_G Gain	±0
Yl_G Phase	±0
G Gain	±0
G Phase	±0

### \*\*Color Matrix Set 3\*\*

G_Cy Gain	±0
G_Cy Phase	±0
Cy Gain	±0
Cy Phase	±0
Cy_B Gain	±0
Cy_B Phase	±0
B Gain	±0
B Phase	±0

Return

## ⑪ Other Set Display

### \*\*Other Set1\*\*

1	Gamma	0.45
2	Knee Point	98%
3	White Clip	110%
4	Flare R	0
	Flare G	0
	Flare B	0
5	Black Stretch	OFF
6	Clean DNR	OFF
7	3D-DNR	OFF
8	2D LPF	OFF

Return

### \*\*Other Set2\*\*

9	Field/Frame	Field
10	Baud Rate	9600bps
11	Component	Y/Pr/Pb
12	Digital Extender	OFF
13	Fan	Auto
14	Auto Focus	OFF
15	Filter	Normal

Return

## ■ Setting and Changing of the Setting Items (User Mode)

### ⑥ Iris, Shutter, Gain Set Display

#### 1. Video Level Adjustment [Picture Level: -50 to +50]

Convergence level of AUTO IRIS/AGC/ELC can be adjusted.

#### 2. Detecting Ratio Adjustment

[Light PEAK/AVG: P50 to A50]

The ratio of AUTO IRIS/AGC/ELC detected peak to average can be adjusted within a range.

#### 3. Photometric Measurement Method Setting

[Light Area: All, Center, Top cut, BTM cut, R/L cut]

A photometric measurement method can be selected for AUTO IRIS/AGC/ELC.

**All:** All the screen area is measured.

**Center:** The screen is measured mainly in the center area, about one-third of both the top and bottom and one-third of both the right and left portions of the screen are excluded from measurement.

**Top cut:** About one-third of the top portion of the screen is excluded from measurement.

**BTM cut:** About one-third of the bottom portion of the screen is excluded from measurement.

**R/L cut:** About one-third of both the right and left portions of the screen are excluded from measurement.

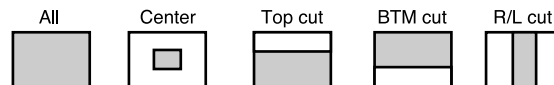

#### 4. Auto Iris Level Fine Adjustment

[Auto Iris Adjust: ON, OFF]

**ON:** Fine adjustment of auto iris convergence level can be made with the iris control when the iris switch on the RCU (RCB) or on the hybrid control panel is in the AUTO position.

**OFF:** The iris control is invalid when the iris switch on the RCU (RCB) or on the hybrid control panel is in the AUTO position.

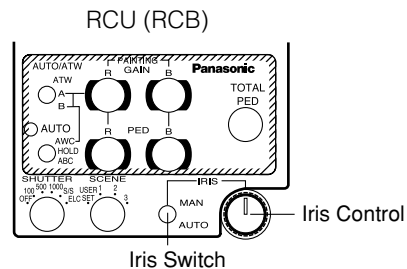

## 5. Electronic Shutter Mode Setting

### [Shutter Mode: Step, ELC, S/Scan]

**Step:** Electronic shutter operates at the speed selected by the Electronic Shutter Step/Synchro Scan Setting (6-6).

**ELC:** Electronic shutter is controlled to automatically adjust the luminance.

**S/Scan (Synchro Scan):** Electronic shutter operates at the speed selected in Electronic Shutter Step/Synchro Scan Setting (6-6).

#### Note

If Frame 1 is selected in CCD Read Out Mode Setting (1-9), Electronic Shutter Mode Setting cannot be added.

## 6. Electronic Shutter Step/Synchro Scan Setting

### [Step/Synchro: OFF, 1/100 to 1/10 000 (step), 60.34Hz to 15.75kHz (Synchro Scan)]

This can be set when “Step” or “Synchro Scan” has been selected as the electronic shutter mode setting (6-5).

- When “Step” has been selected as the electronic shutter mode setting (6-5):

**OFF:** The electronic shutter is set to OFF.

**1/100, 1/250, 1/500, 1/1 000, 1/2 000, 1/4 000, 1/10000:**

The electronic shutter operates at the shutter speed selected.

- When “Synchro Scan” has been selected as the electronic shutter mode setting (6-5):

When the screen of a work station, etc. is to be shot, the noise on the horizontal bars can be reduced by proceeding with the synchro-scan adjustment.

- \* Refer to the table below for the light quantity settings to be used in each shutter mode and during synchro scanning.

Shutter Speed	Synchro-scan	Required luminance ratio
OFF	—	1
1/100	100.3 Hz	2
1/250	250.0 Hz	4
1/500	492.2 Hz	8
1/1 000	984.4 Hz	16
1/2 000	1.969 kHz	32
1/4 000	3.938 kHz	64
1/10 000	7.875 kHz	160

#### Notes

- In case of using the RCU (RCB), none of the shutter speeds – 1/250, 1/2 000, 1/4 000, and 1/10 000 can be selected.
- In case of using the hybrid control panel, only OFF, 1/100, or ELC can be selected.
- If the lens iris switch is at M (Manual) when operating the camera alone or when the iris switch on the RCU (RCB) is at AUTO, ELC may not function. Set the lens iris switch to A (Auto).
- Flickering may increase at ELC under fluorescent lights.

## 7. Gain Setting

**[Gain: Auto, 0 dB to 30 dB, N/Eye L, N/Eye H]  
(models AW-E750, AW-E655, AW-E650)**

**[Gain: Auto 0 dB to 30 dB, N/Eye]  
(model AW-E350)**

When “Auto” has been selected as the CCD storage time setting (6-10), the setting is kept to “Auto” regardless of the gain setting selected here.

**Auto:** The light quantity is adjusted automatically.

**0 dB:** Under normal circumstances, this setting is used.

**1 dB to 30 dB:** Use this setting while shooting dark scenes if it is not possible to achieve a satisfactory video output even when the lens diaphragm is opened.

### **AW-E750, AW-E655, AW-E650**

**N/Eye L (Night Eye L) :** Use this setting if it is not possible to achieve a satisfactory video output even at 30 dB.

**N/Eye H (Night Eye H) :** Use this setting if it is not possible to achieve a satisfactory video output even at the Night Eye L setting.

### **AW-E350**

**N/Eye (Night Eye) :** Use this setting if it is not possible to achieve a satisfactory video output even at 30 dB.

## Notes

- Only 0 dB, 9 dB, or 18 dB, AGC LOW, AGC HIGH can be selected in case of using the RCU (RCB). If the lens iris switch is at MANUAL, when operating the camera alone or when the iris switch on the RCU (RCB, Hybrid control panel) is at AUTO, AGC may not function.
- AGC HIGH when the AGC selection switch on the hybrid control panel is at AGC.
- 0 dB when the manual gain switch on the hybrid control panel is at LOW, 9 dB when it is at MID, or 18 dB when it is at HIGH.

### Manual GAIN Switch AGC Switch

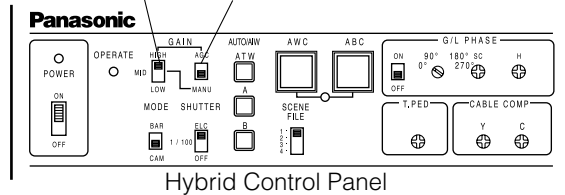

## 8. Digital Gain Up Setting

**[Digital Gain Up: 0dB, 6dB, 12dB, 18dB, 24dB, 30dB]**

This can be set when a setting other than “Auto” has been selected as the gain setting (6-7).

**0 dB:** Under normal circumstances, this setting is used.

**6 dB to 30 dB:** Use this setting while shooting dark scenes if it is not possible to achieve a satisfactory video output even when the lens diaphragm is opened and “Night Eye” is selected as the gain setting (6-7).

## 9. AGC Maximum Gain Setting

**[AGC Max Gain: 6dB, 12dB, 18dB, 24dB, N/Eye L, N/Eye H] (AW-E750, AW-E655, AW-E650)**

**[AGC Max Gain: 6dB, 12dB, 18dB, 24dB, N/Eye] (AW-E350)**

This is used to set the maximum gain up when “Auto” has been selected as the gain setting (6-7).

## 10. CCD Storage Time setting

**[Charge Time: Auto, OFF, 1/30s, 1/15s, 1/8s, 1/4s, 1/2s, 1s, 2s]**

This is used to set the CCD storage time.

**OFF:** Under normal circumstances, this setting is used.

**Auto:** ALC is performed followed by AGC and then by the data storage, and the camera automatically adjusts the light quantity.

If the electronic shutter mode setting (6-5) is set to “ELC”, ELC is performed followed by ALC, AGC and then by the data storage in this order, and the light quantity is automatically adjusted. The electronic shutter mode setting (6-5) cannot be changed at this time.

**1/30s to 2s:** Use this setting if it is not possible to achieve a satisfactory video output even when the gain up setting is used.

The electronic shutter go “OFF” at this time, the electronic shutter mode setting (6-5) and electronic shutter step/synchro scan setting (6-6) cannot be changed.

\* If the CCD read out (mode) setting (11-9) has been set to “Frame1” or “Frame2”, 1/15s to 2s is selected as the storage time setting, and the sensitivity is set to about one-half of that obtained with when the CCD read-out (mode) setting (11-9) has been set to “Field”.

## 7 Color Set Display

### 1. Chroma Level Adjustment [Chroma Level: -3 to +3]

Chroma Level can be decreased or increased to three levels.

### 2. White Balance Setting

[White Bal: ATW, AWC A, AWC B, P SET 3 200K, P SET 5 600K]

**ATW:** The white balance is automatically adjusted to the optimum position.

**AWC A, AWC B:** Color temperature conditions at two points can be stored at AWC A and AWC B. Once the white balance is adjusted with the ITEM/AWC switch on the back of the camera, it is no longer necessary to set the white balance again if you simply select AWC A or AWC B, provided that the camera is used under the same conditions.

Fine color adjustment can be made after setting AWC by red/blue gain adjustment in Painting Setting or from the RCU (RCB).

**P SET 3 200K:** The white balance is adjusted to 3 200K illumination.

**P SET 5 600K:** The white balance is adjusted to 5 600K illumination.

#### Note

Neither P SET 3 200K nor P SET 5 600K can be set from the RCU (RCB) or the hybrid control panel.

### 3. ATW Speed Setting

[ATW Speed: SLOW 2, SLOW 1, MID, FAST 1, FAST 2]  
ATW Speed can be set.

### 4. Black Level Setting [Pedestal: -150 to +150]

The black level (pedestal) of the luminance (Y) signal can be set. Used in adjusting the black levels of two or more cameras.

### 5. Painting Setting

[Painting: R Gain, B Gain, R Pedestal, B Pedestal: -150 to +150]

**R Gain, B Gain:** Fine adjustment of the white balance can be made after AWC setting when AWC A or AWC B is selected in White Balance Setting. In case of using the RCU (RCB), use the R/B gain controls for this purpose. The set value returns to  $\pm 0$  after AWC setting in using the camera alone.

**R Pedestal, B Pedestal:** Fine adjustment of the black balance can be made after ABC setting.

In case of using the RCU (RCB), use the R/B pedestal controls for this purpose. The set value returns to  $\pm 0$  after ABC setting in using the camera alone.

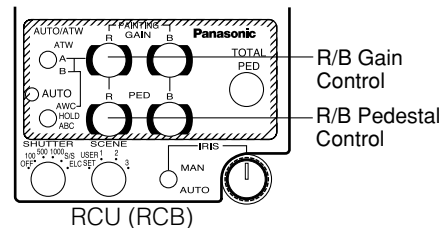



## 6. Negative/Positive Selection

**[Nega/Posi: Posi, Nega]**

**Posi:** Normal image

**Nega:** Image is shown reversed in darkness and color.

## 8 G/L Adjustment Set Display

### 1. Horizontal Phase Adjustment

**[H Phase: -206 to +49]**

Horizontal phase can be adjusted when a genlock signal is supplied.

### 2. Subcarrier Phase Coarse Adjustment

**[SC Coarse: 1, 2, 3, 4]**

Coarse adjustment of subcarrier phase can be made when a genlock signal is supplied.

### 3. Subcarrier Phase Fine Adjustment

**[SC Fine: -511 to +511]**

Fine adjustment of subcarrier phase can be made when a genlock signal is supplied.

### 4. Color Bar Setup Setting

**[Color Bar Set: 0.0 IRE, 7.5 IRE]**

The setup level of color bar can be adjusted.

## 9 Detail Set Display

### 1. Detail Level Setting [Detail: OFF, Low, High]

Contour correction quantity can be selected.

Detail settings made using the Horizontal/Vertical Detail Level HIGH/LOW Setting.

### 2. Horizontal Detail Level HIGH Setting

**[H Detail Level H: L+1 to +63]**

### 3. Vertical Detail Level HIGH Setting

**[V Detail Level H: L+1 to +31]**

### 4. Horizontal Detail Level LOW Setting

**[H Detail Level L: 0 to H-1]**

### 5. Vertical Detail Level LOW Setting

**[V Detail Level L: 0 to H-1]**

Detail level can be set in horizontal (H) and vertical (V) directions with the Detail Level Setting (9-1) at HIGH or LOW.

Whichever the direction, H or V, the set level at HIGH must be at least one position higher than that at LOW.

### 6. Detail Band Setting [Detail Band: 1 to 5]

A contour correction band can be set with the Detail Level Setting (9-1) at HIGH or LOW. The higher setting, the finer will be the detail.

## 7. Noise Suppress Compensation Level Setting

### [Noise Suppress: 1 to 10]

Screen noise can be reduced with the Detail Level Setting (⊖-1) at HIGH or LOW. If the noise suppress compensation level is set too high, a fine object will be reproduced less sharply.

## 8. Level Dependent Compensation Level Setting

### [Level Dependent: 0% to 25%]

Screen noise due to the detail of dark parts of an object can be reduced.

If level dependent compensation level is set too high, however, hair, for example, will be reproduced less sharply.

## 9. Dark Detail Compensation Level Setting

### [Dark Detail: 0 to 5]

The contours of the darker portions of an object can be emphasized.

This setting is possible only when the Level Dependent Compensation Level Setting (⊖-9) is set to 0 %.

## 10. Chroma Detail Compensation Level Setting

### [Chroma Detail: 0 to 15]

The contours of high-hue portions of an object can be emphasized.

## 11. Flesh DTL Level Setting

### [Flesh DTL Level: Low, Mid, High]

**LOW:** The roughness of the flesh tones is minimized.

**MID:** This is the standard setting.

**HIGH:** The outlines of the flesh tones are accentuated.

## 12. Corner Detail Setting [Corner Detail: OFF, ON]

Corner detail, which improves the resolution of corners, can be turned on or off when the Detail Level Setting (⊖-1) is at HIGH or LOW.

## 13. Precision Detail Level Setting

### [Precision Detail: OFF, LOW, HIGH]

This setting is to narrow detail width and suppress detail glare.

## ⑩ Color Matrix Set Display

**B\_Mg Gain:** Increases or decreases the intermediate color between blue and magenta.

**B\_Mg Phase:** Varies the hue of the intermediate color between blue and magenta.

**Mg Gain:** Increases or decreases the magenta.

**Mg Phase:** Varies the hue of the magenta.

**Mg\_R Gain:** Increases or decreases the intermediate color between magenta and red.

**Mg\_R Phase:** Varies the hue of the intermediate color between magenta and red.

**R Gain:** Increases or decreases the red.

**R Phase:** Varies the hue of the red.

**R\_YI Gain:** Increases or decreases the intermediate color between red and yellow.

**R\_YI Phase:** Varies the hue of the intermediate color between red and yellow.

**YI Gain:** Increases or decreases the intermediate color of yellow.

**YI Phase:** Varies the hue of the yellow.

**YI\_G Gain:** Increases or decreases the intermediate color between yellow and green.

**YI\_G Phase:** Varies the hue of the intermediate color between yellow and green.

**G Gain:** Increases or decreases the green.

**G Phase:** Varies the hue of the green.

**G\_Cy Gain:** Increases or decreases the intermediate color between green and cyan.

**G\_Cy Phase:** Varies the hue of the intermediate color between green and cyan.

**Cy Gain:** Increases or decreases the cyan.

**Cy Phase:** Varies the hue of the cyan.

**Cy\_B Gain:** Increases or decreases the intermediate color between cyan and blue.

**Cy\_B Phase:** Varies the hue of the intermediate color between cyan and blue.

**B Gain:** Increases or decreases the intermediate color between blue and magenta.

**B Phase:** Varies the hue of the intermediate color between blue and magenta.

## **⑪ Other Set Display**

### **1. Gamma Correction Level Setting**

**[Gamma: 0.35 to 0.55]**

Gamma correction level can be set.

### **2. Knee Compensation Level Setting**

**[Knee Point: 88% to 98%, Dynamic]**

**88% to 98%:** The level of video signals subject to knee compensation (knee point) can be set.

**Dynamic:** Knee compensation level is automatically adjusted according to the scene.

### **3. White Clip Level Setting**

**[White Clip: 95% to 110%]**

The peak level of video signals to be white-clipped can be set.

### **4. Flare Correction Level Setting**

**[Flare R/G/B: 0 to 100]**

Flare correction level can be adjusted.

\* Flare correction level has already been adjusted prior to shipment from the factory.

### **5. Black Stretch Setting [Black Stretch: ON, OFF]**

Black stretch to correct the suppression of black portions at low luminance can be set to ON or OFF.

### **6. Clean DNR Setting [Clean DNR: HIGH, LOW, OFF]**

This enables the clean DNR effect to be selected.

### **7. 3D-DNR Setting [3D-DNR: OFF, Low, Mid, High]**

This enables the 3D-DNR effect to be selected.

\* When “Mid” or “High” is selected, the noise is reduced but lag increases.

### **8. 2-dimensional Lowpass Filter Setting**

**[2D LPF: OFF, LOW, HIGH]**

The 2D lowpass filter that reduces moire and cross color can be set.

### **9. CCD Read Out Mode Setting**

**[Field/Frame: Field, Frame 1, Frame 2]**

**Field:** CCD storage will be by field storage.

**Frame 1:** Vertical resolution increases in frame storage.

**Frame 2:** Vertical resolution is raised without increasing residual images by frame storage and electronic shutter.

### **10. PC Control Access Speed Setting**

**[Baud Rate: 1 200bps, 2 400bps, 4 800bps, 9 600bps]**

This setting is to select a communication speed in controlling the camera from the computer.

### 11. Component Output Setting

#### [Component: RGB, Y/Pr/Pb, Y/C]

This enables RGB, Y/Pr/Pb or Y/C to be selected as the component signals which are to be output from the I/F REMOTE connector.

### 12. Digital Extender Setting [Digital Extender: OFF, ON]

**OFF:** Under normal circumstances, this setting is used.

**ON:** An extender effect which is approximately 1.5 times greater is achieved. However, the resolution drops when the digital extender is set to "ON".

### 13. Fan Setting [Fan: OFF, Auto]

#### (models AW-E750, AW-E655)

**OFF:** Select this setting to stop the fan when its operating sound is found to be bothersome in a studio or other such environment.

**Auto:** The temperature is detected automatically, and the fan starts operating when the temperature exceeds approx. 10°C in the storage mode or approx. 35°C in any other mode. Under normal circumstances, the "Auto" setting is used.

### 14. Auto Focus Setting [Auto Focus: OFF, ON] (model AW-E655)

This enables auto focus ON and OFF to be controlled when the zoom/focus cable of a Canon AF lens has been connected to the ZOOM/FOCUS connector on the AW-E655.

### 15. Filter Setting

#### [Filter: IR Through, Normal, 1/16ND, 1/64ND]

**IR Through:** The infrared shooting mode is established. Irradiate the subject with infrared light.

**Normal:** Under normal circumstances, this setting is used.

**1/16ND:** The 1/16 ND filter is inserted. Use this setting when the lens cannot be stopped down enough by the diaphragm.

**1/64ND:** The 1/64 ND filter is inserted. Use this setting when the lens cannot be stopped down enough by the diaphragm even at the 1/16ND setting.

# SETTING AND CHANGING THE OPTIONAL CARDS

## 12 Optional Card Setting Sub Menu

This sub menu appears when a studio card (AW-PB506 or AW-PB305) has been inserted into the optional card slot.

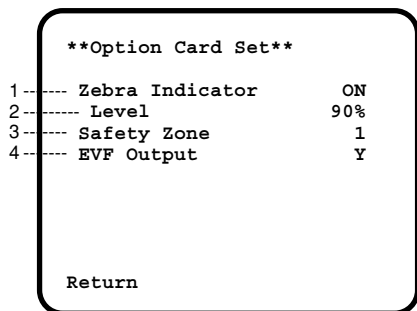

\* The sub menu shown below appears only when an optional card (AW-PB504) equipped with a ZOOM/FOCUS connector has been inserted in the model AW-E650.

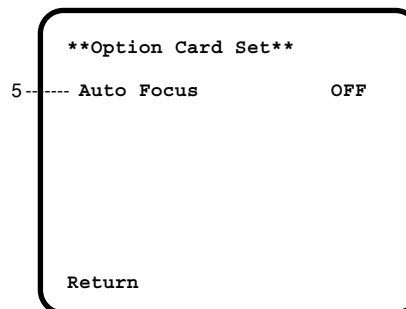

### 1. Zebra Indicator Setting [Zebra Indicator: ON, OFF]

This is used to select whether to display the zebra pattern on the viewfinder.

**ON:** The zebra pattern is displayed on the viewfinder.

**OFF:** The zebra pattern is not displayed on the viewfinder.

\* If "CVBS" is selected as the EVF output setting (12-4), the zebra pattern will not be displayed on the viewfinder even when "ON" has been set for the zebra pattern display.

## 2. Zebra Level Setting [Level: 70% to 110%]

This enables the zebra pattern to be displayed so that it will provide as a general guideline for the luminance level.

\* It can be set when “ON” has been selected as the zebra indicator setting (10-1).

## 3. Safety Zone Setting [Safety Zone: OFF, 1, 2, 3, 4, 5]

This is used to select the type of safety zone which is displayed on the viewfinder. A safety zone is not displayed when “OFF” is selected.

\* The safety zone and center marker indicate electrical positions and, as such, they may be at variance with their optical positions.

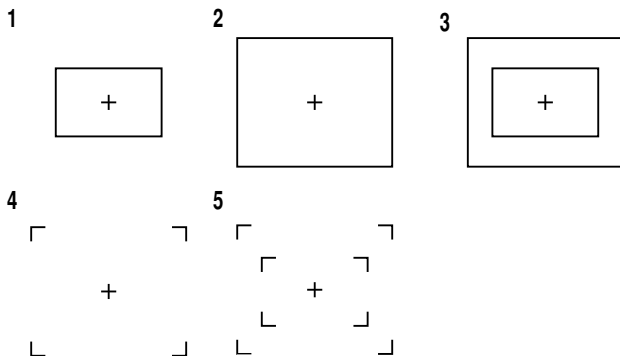

The inside and outside frames denote safety zones of about 90% and about 95%, respectively.

## 4. EVF Output Setting [EVF Output: Y, CVBS]

This is used to set the signals to be output to the viewfinder.

**Y:** The luminance signal is output to the viewfinder.

**CVBS:** The color signals are output to the viewfinder.

\* When “CVBS” has been selected as the setting, the zebra pattern will not be displayed on the viewfinder.

## 5. Auto Focus [Auto Focus: OFF, ON]

This enables auto focus ON and OFF to be controlled when the zoom/focus cable of a Canon AF lens has been connected to the ZOOM/FOCUS connector of the optional card.

# SETTING TO INITIAL SET

## ■ Setting to initial set

In case of the wrong setting in any use mode, take the following steps to return to the initial settings.

- (1) Select [Initialize Data] on the main menu screen of each Use Mode. (See page 29.)  
Press the YES/ABC switch, then [Initialize Data] screen shown for about 10 seconds.
- (2) Press the YES/ABC switch within about 10 seconds to return to the initial settings, the existing settings

are initialized, the screen shown at ②, and the camera returns to main menu.

- (3) If the NO/BAR switch is pressed, or if the YES /ABC switch is not pressed, within about 10 seconds, the screen shown at ③, and the camera returns to main menu, and the existing settings are not initialized.

### Note

If you are using an option card, the Option Card Setting Submenu will not be initialized even if "Return to Initialize" is performed.

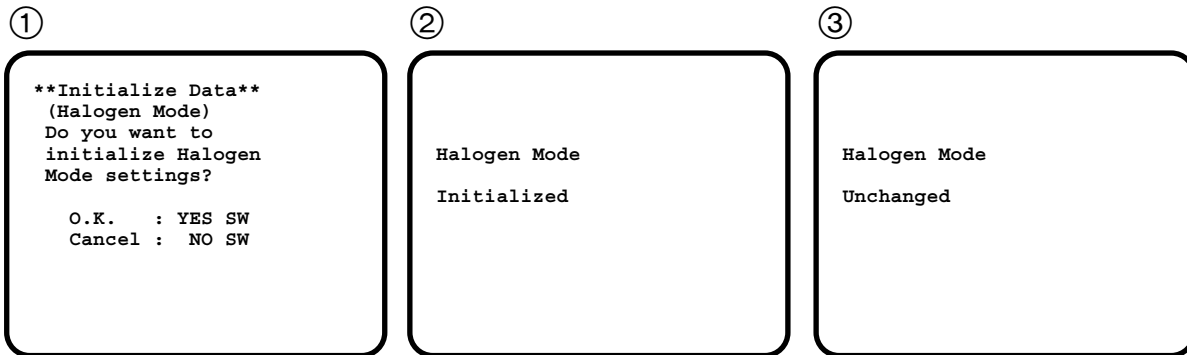



## ■ INITIAL SETTINGS OF THE SETTING ITEMS (Factory preset values)

### ● Halogen, Fluorescent, Outdoor Mode

	Item	Halogen mode	Fluorescent mode	Outdoor mode
Brightness Set	Picture Level Light PEAK/AVG Light Area Auto ND (ELC) Auto Gain Up AGC Max Gain  Manual Gain Up Digital Gain Up Charge Time Pedestal	±0 0 Top cut OFF OFF ---  0dB 0dB OFF ±0	±0 0 Top cut OFF OFF ---  0dB 0dB OFF ±0	±0 0 Top cut ON ON N/Eye H* <sup>1</sup> N/Eye * <sup>2</sup> --- --- OFF -40
Color Set	Chroma Level Flesh Tone White Bal ATW Speed Nega/Posi	±0 ±0 AWC A --- Posi	±0 ±0 AWC A --- Posi	±0 ±0 ATW Mid Posi
G/L, Color Bar Set	H Phase SC Coarse SC Fine Color Bar Set	±0 1 ±0 7.5 IRE	±0 1 ±0 7.5 IRE	±0 1 ±0 7.5 IRE
Sharpness (DTL) Set	DTL Select Level Noise Suppress Clean DNR 3D-DNR DTL Flesh Tone	Sharpness High OFF OFF OFF Mid	Sharpness High OFF OFF OFF Mid	Sharpness High OFF OFF OFF Mid

\*1: AW-E750, AW-E655, AW-E650 \*2: AW-E350

## ● Halogen, Fluorescent, Outdoor Mode

	Item	Halogen mode	Fluorescent mode	Outdoor mode
Other Set	Contrast (Gamma) Shutter Speed Synchro Scan V Resolution Baud Rate Component Digital Extender Fan Auto Focus Filter	Mid OFF --- Normal 9 600bps Y/Pr/Pb OFF Auto OFF Normal	Mid OFF --- Normal 9 600bps Y/Pr/Pb OFF Auto OFF Normal	Mid Auto ND --- Normal 9 600bps Y/Pr/Pb OFF Auto OFF Normal

## ● User Mode

	Item	User mode		Item	User mode
Iris, Shutter, Gain Set	Picture Level	±0	Color Set	Chroma Level	+2
	Light PEAK/AVG	0		White Bal	AWC A
	Light Area	Top cut		ATW Speed	Mid
	Auto Iris Adjust	OFF		Pedestal	±0
	Shutter Mode	Step		Painting	
	Step/Synchro	OFF		R Gain	±0
	Gain	0dB		B Gain	±0
	Digital Gain Up	0dB		R Pedestal	±0
	AGC Max Gain	---		B Pedestal	±0
	Charge Time	OFF		Nega/Posi	Posi
			G/L, Color Bar Set	H Phase	±0
				SC Coarse	1
				SC Fine	±0
				Color Bar Set	7.5 IRE

## ● User Mode

	Item	User mode
Detail Set 1	Detail	High
	H Detail Level H	15
	V Detail Level H	12
	H Detail Level L	8
	V Detail Level L	7
	Detail Band	2
	Noise Suppress Level Dependent	3 0%
	Dark Detail	0
Detail Set 2	Chroma Detail	0
	Flesh DTL Level	Mid
	Corner Detail	OFF
	Precision Detail	OFF
Color Matrix Set 1	B_Mg Gain	±0
	B_Mg Phase	±0
	Mg Gain	+27
	Mg Phase	±0
	Mg_R Gain	±0
	Mg_R Phase	±0
	R Gain R Phase	+15 ±0
Color Matrix Set 2	R_YI Gain	±0
	R_YI Phase	±0
	YI Gain	+18
	YI Phase	+6
	YI_G Gain	±0
	YI_G Phase	±0
	G Gain G Phase	+30 +112

	Item	User mode
Color Matrix Set 3	G_Cy Gain	±0
	G_Cy Phase	±0
	Cy Gain	+44
	Cy Phase	-15
	Cy_B Gain	±0
	Cy_B Phase	±0
	B Gain B Phase	-20 +36
	Other Set 1	Gamma
Knee Point		88%
White Clip		110%
Flare R		0
Flare G		0
Flare B		0
Black Stretch		OFF
Clean DNR		OFF
3D-DNR		OFF
2D LPF		OFF
Other Set 2	Field/Frame Baud Rate Component Digital Extender Fan Auto Focus Filter	Field 9 600bps Y/Pr/Pb OFF Auto OFF Normal

# APPEARANCE

(AW-E750)

Unit: inch (mm)

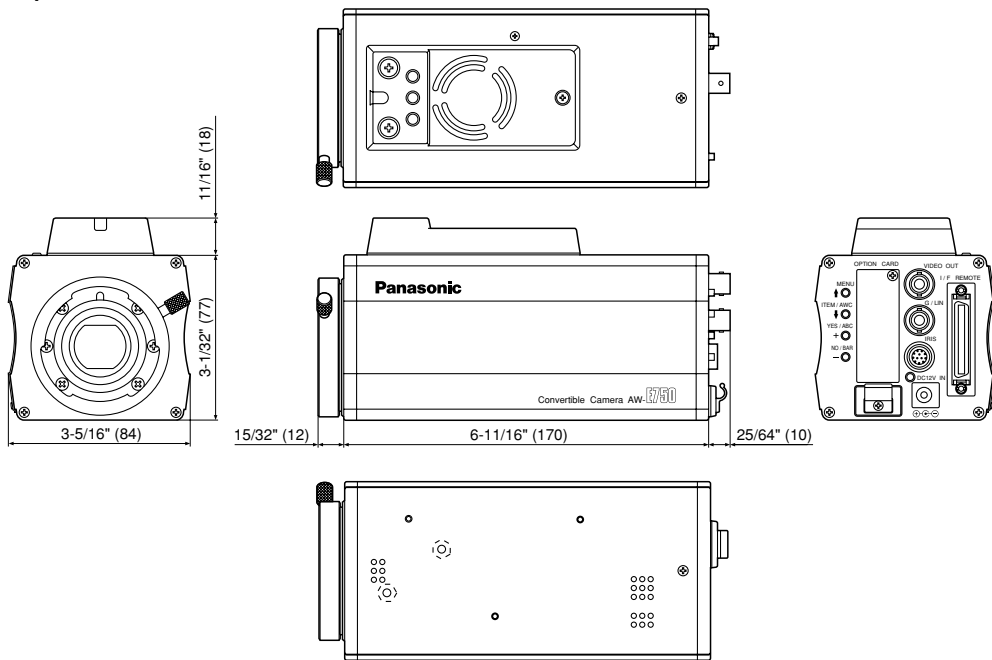

Unit: inch (mm)

(AW-E655)

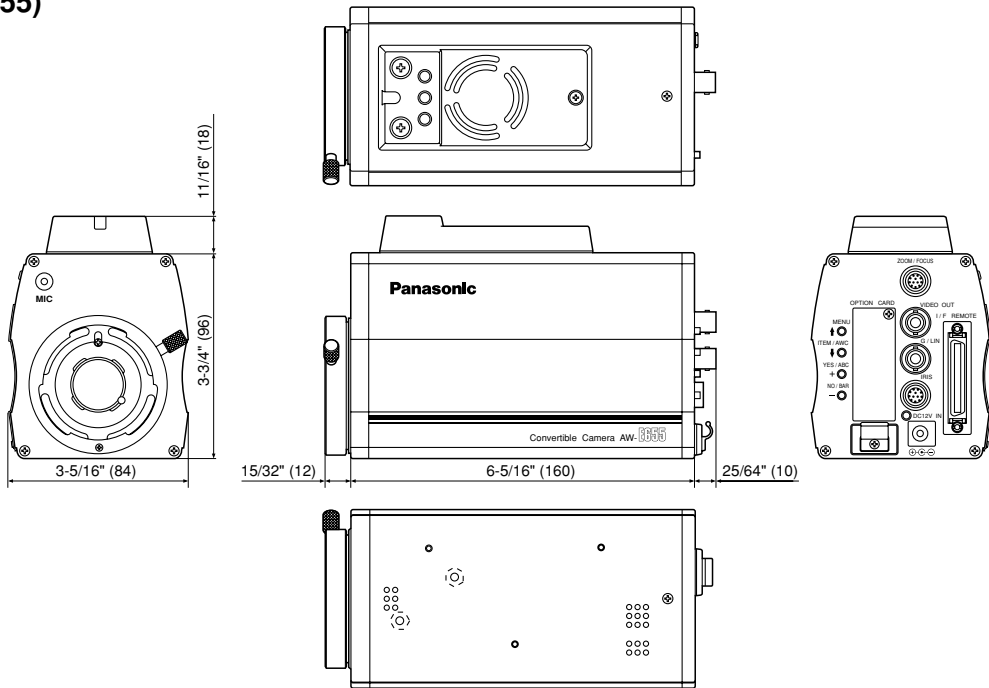



(AW-E350)

Unit: inch (mm)

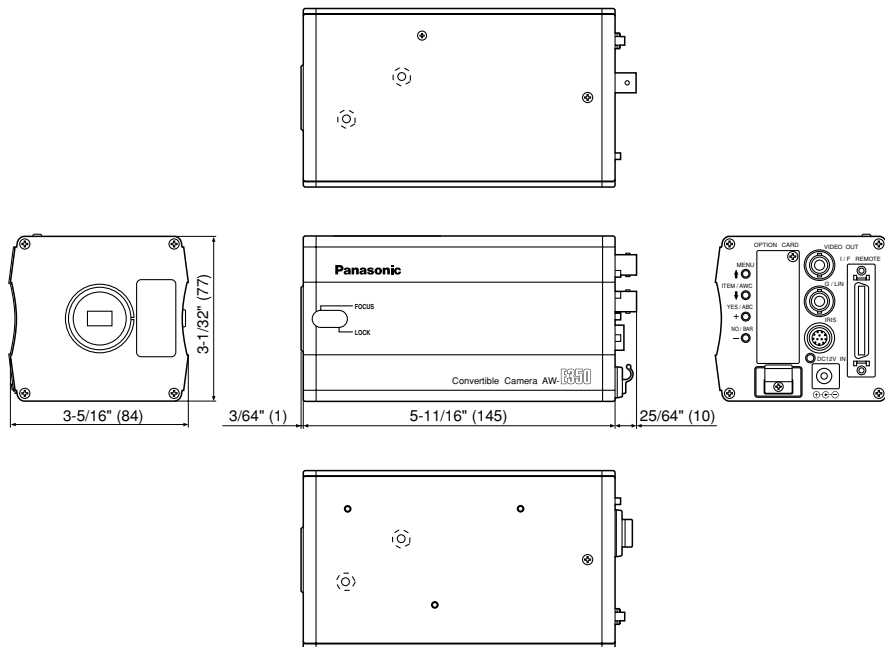

# SPECIFICATIONS

## ■ AW-E750, AW-E655

Source Voltage: DC 12 V Power consumption: 12.6 W (AW-E750), 12.0 W (AW-E655)

indicates safety information.

	<b>AW-E750</b>	<b>AW-E655</b>
<b>Optical system</b>	2/3" prism, F1.4	1/2" prism, F1.4
<b>Pick up device</b>	2/3" interline-type CCD	1/2" interline-type CCD
<b>Number of valid pixels</b>	768 x 494 (approx. 380,000 pixels)	
<b>Total number of pixels</b>	811 x 508 (approx. 410,000 pixels)	
<b>Scanning system</b>	525 scanning lines, 60 fields, 30 frames	
<b>Synchronizing system</b>	Internal synchronization: EIA standard; external synchronization: BBS or VBS (BNC x 1, D-sub 50P x 1)	
<b>Video output</b>	Composite: 1.0 Vp-p/75 ohms (BNC x 1, D-sub 50 P x 1) Y/C Y: 1.0 Vp-p/75 ohms; C: 0.286 Vp-p/75 ohms (burst) (D-sub 50P x 1) Y/Pr/Pb Y: 1 Vp-p/75 ohms; Pr, Pb: 0.7 Vp-p/75 ohms (D-sub 50P x 1) RGB G: 1 Vp-p/75 ohms; RB: 0.7 Vp-p/75 ohms (D-sub 50P x 1)	
<b>Standard illumination, color temperature</b>	2,000 lx (F14, 3,200K)	
<b>Minimum illumination</b>	0.00005 lx at F1.4, Night Eye mode, 30 dB digital gain, 2s storage time, output of 70% or above	
<b>S/N ratio</b>	67 dB (Y signal, DTL OFF, DNR ON)	
<b>Horizontal resolution</b>	850 TV lines (high-band DTL ON, center area)	
<b>Registration</b>	0.05% (entire screen, excluding effects of lens)	
<b>Geometric distortion</b>	0%	
<b>Contour correction</b>	Horizontal, vertical (2H)	
<b>White balance</b>	AWC A, AWC B (R/B gain, painting), ATW, 3,200K, 5,600K preset	
<b>Black balance</b>	Auto (R/B pedestal, painting function)	
<b>Chroma amount variability</b>	7-level variability	
<b>Encoding system</b>	OFF, Low, High	
<b>Gain selection</b>	0 to 30 dB in steps, AGC, Night Eye L, H	



	<b>AW-E750</b>	<b>AW-E655</b>
<b>Electronic shutter speeds</b>	1/100, 1/250, 1/500, 1/1000, 1/2000, 1/4000, 1/10000; ELC, synchro scanner (60.34 Hz to 15.75 kHz)	
<b>CCD readout selection</b>	Field, frame1, frame2	
<b>Color bars</b>	SMPTE	
<b>Lens mount</b>	2/3" bayonet mount	1/2" bayonet mount
<b>Lens diaphragm</b>	Auto, Manual (but only with remote control), adjust ON, OFF	
<b>Internal filters</b>	—	IR Through, Normal, 1/16ND, 1/64ND
<b>Selector switches</b>	MENU(↑) ITEM/AWC (↓) (AWC: when menu screen is not displayed) UP/ABC (+) (ABC: when menu screen is not displayed) NO/BAR (-) (BAR: when menu screen is not displayed)	
<b>Input/output connectors</b>	VIDEO OUT BNC connector G/L IN BNC connector IRIS 12P round connector DC 12V IN DC connector I/F REMOTE 50P D-sub connector	VIDEO OUT BNC connector G/L IN BNC connector IRIS 12P round connector DC 12V IN DC connector I/F REMOTE 50P D-sub connector ZOOM/FOCUS 12P round connector
<b>Indicator</b>	Red LED; power ON when lighted	
<b>Allowable temperature ranges</b>	For storage: -20°C to +60°C For guaranteeing performance: +5°C to +35°C For guaranteeing operation: -10°C to +45°C	
<b>Allowable humidity ranges</b>	For storage: 20% to 90% For operation: 20% to 90%	
<b>Dimensions (W x H x D)</b>	3-5/16"x3-3/4"x7-9/16" (84x95x192 mm)	3-5/16"x4-1/2"x7-3/16" (84x114x182 mm)
<b>Weight</b>	2.4 lbs (1.1 kg)	2.6 lbs (1.2 kg)

■ AW-E650, AW-E350

Source Voltage: DC 12 V    Power consumption: 11.8 W (AW-E650), 11.3 W (AW-E350)
----------------------------------------------------------------------------------

 indicates safety information.

	<b>AW-E650</b>	<b>AW-E350</b>
<b>Optical system</b>	1/2" prism, F1.4	1/3" prism, F1.4
<b>Pick up device</b>	1/2" interline-type CCD	1/3" interline-type CCD
<b>Number of valid pixels</b>	768 x 494 (approx. 380,000 pixels)	
<b>Total number of pixels</b>	811 x 508 (approx. 410,000 pixels)	
<b>Scanning system</b>	525 scanning lines, 60 fields, 30 frames	
<b>Synchronizing system</b>	Internal synchronization: EIA standard; external synchronization: BBS or VBS (BNC x 1, D-sub 50P x 1)	
<b>Video output</b>	Composite: 1.0 Vp-p/75 ohms (BNC x 1, D-sub 50 P x 1) Y/C Y: 1.0 Vp-p/75 ohms; C: 0.286 Vp-p/75 ohms (burst) (D-sub 50P x 1) Y/Pr/Pb Y: 1 Vp-p/75 ohms; Pr, Pb: 0.7 Vp-p/75 ohms (D-sub 50P x 1) RGB G: 1 Vp-p/75 ohms; RB: 0.7 Vp-p/75 ohms (D-sub 50P x 1)	
<b>Standard illumination, color temperature</b>	2,000 lx (F14, 3,200K)	2,000 lx (F9.5, 3,200K)
<b>Minimum illumination</b>	0.00005 lx at F1.4, Night Eye mode, 30 dB digital gain, 2s storage time, output of 70% or above	0.00015 lx at F1.4, Night Eye mode, 30 dB digital gain, 2s storage time, output of 70% or above
<b>S/N ratio</b>	67 dB (Y signal, DTL OFF, DNR ON)	66 dB (Y signal, DTL OFF, DNR ON)
<b>Horizontal resolution</b>	850 TV lines (high-band DTL ON, center area)	
<b>Registration</b>	0.05% (entire screen, excluding effects of lens)	
<b>Geometric distortion</b>	0%	
<b>Contour correction</b>	Horizontal, vertical (2H)	
<b>White balance</b>	AWC A, AWC B (R/B gain, painting), ATW, 3,200K, 5,600K preset	
<b>Black balance</b>	Auto (R/B pedestal, painting function)	
<b>Chroma amount variability</b>	7-level variability	
<b>Encoding system</b>	OFF, Low, High	
<b>Gain selection</b>	0 to 30 dB in steps, AGC, Night Eye L, H	0 to 30 dB in steps, AGC, Night Eye

	<b>AW-E650</b>	<b>AW-E350</b>
<b>Electronic shutter speeds</b>	1/100, 1/250, 1/500, 1/1000, 1/2000, 1/4000, 1/10000; ELC, synchro scanner (60.34 Hz to 15.75 kHz)	
<b>CCD readout selection</b>	Field, frame1, frame2	
<b>Color bars</b>	SMPTE	
<b>Lens mount</b>	1/2" bayonet mount	1/3" C mount
<b>Lens diaphragm</b>	Auto, Manual (but only with remote control), adjust ON, OFF	
<b>Internal filters</b>	IR Through, Normal, 1/16ND, 1/64ND	—
<b>Selector switches</b>	MENU(↑) ITEM/AWC (↓) (AWC: when menu screen is not displayed) UP/ABC (+) (ABC: when menu screen is not displayed) NO/BAR (-) (BAR: when menu screen is not displayed)	
<b>Input/output connectors</b>	VIDEO OUT BNC connector G/L IN BNC connector IRIS 12P round connector DC 12V IN DC connector I/F REMOTE 50P D-sub connector	
<b>Indicator</b>	Red LED; power ON when lighted	
<b>Allowable temperature ranges</b>	For storage: -20°C to +60°C For guaranteeing performance: +5°C to +35°C For guaranteeing operation: -10°C to +45°C	
<b>Allowable humidity ranges</b>	For storage: 20% to 90% For operation: 20% to 90%	
<b>Dimensions (W x H x D)</b>	3-5/16"x3-1/32"x6-15/16" (84 x 77 x 177 mm)	3-5/16"x3-1/32"x6-1/8" (84 x 77 x 156 mm)
<b>Weight</b>	2.0 lbs (0.92 kg)	1.7 lbs (0.77 kg)

Weight and Dimensions indicated above are approximate.  
Specifications are subject to change without notice.

# STANDARD ACCESSORIES

Rubber Sheet ..... 1  
Mounting Adaptor ..... 1  
Screw ..... 2

Mounting Spacer  
(models AW-E750, AW-E655 only) ..... 1







---

# Panasonic

**PANASONIC BROADCAST & TELEVISION SYSTEMS COMPANY**  
UNIT COMPANY OF MATSUSHITA ELECTRIC CORPORATION OF AMERICA

**Executive Office:**

One Panasonic Way 4E-7, Secaucus, NJ 07094 (201) 348-7000

**EASTERN ZONE:**

One Panasonic Way 4E-7, Secaucus, NJ 07094 (201) 348-7621

**Southeast Region:**

1225 Northbrook Parkway, Ste 1-160, Suwanee, GA 30024 (770) 338-6835

**Central Region:**

1707 N Randall Road E1-C-1, Elgin, IL 60123 (847) 468-5200

**WESTERN ZONE:**

3330 Cahuenga Blvd W., Los Angeles, CA 90068 (323) 436-3500

**Government Marketing Department:**

52 West Gude Drive, Rockville, MD 20850 (301) 738-3840

**Broadcast PARTS INFORMATION & ORDERING:**

9:00 a.m. – 5:00 p.m. (EST) (800) 334-4881/24 Hr. Fax (800) 334-4880

Emergency after hour parts orders (800) 334-4881

**TECHNICAL SUPPORT:**

Emergency 24 Hour Service (800) 222-0741

**Panasonic Canada Inc.**

5770 Ambler Drive, Mississauga, Ontario L4W 2T3 (905) 624-5010

**Panasonic de Mexico S.A. de C.V.**

Av angel Urraza Num. 1209 Col. de Valle 03100 Mexico, D.F. (52) 1 951 2127

**Panasonic Sales Company**

**Division of Matsushita Electric of Puerto Rico Inc.**

San Gabriel Industrial Park, 65th Infantry Ave., Km. 9.5, Carolina, Puerto Rico 00630 (787) 750-4300

